

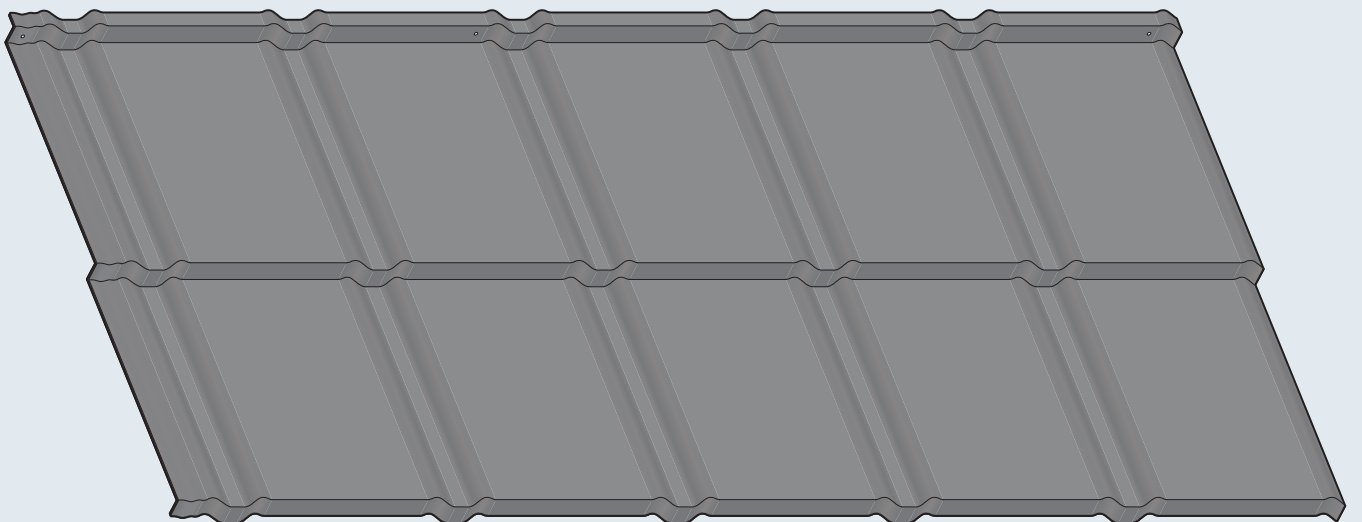

Montageempfehlung



TREND



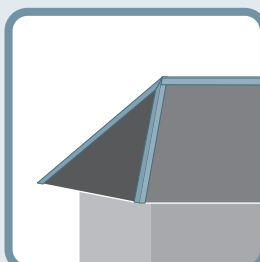
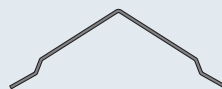
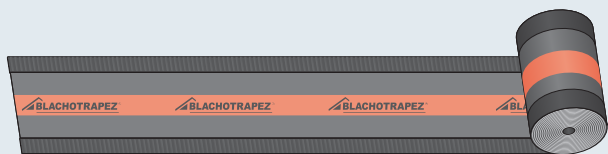
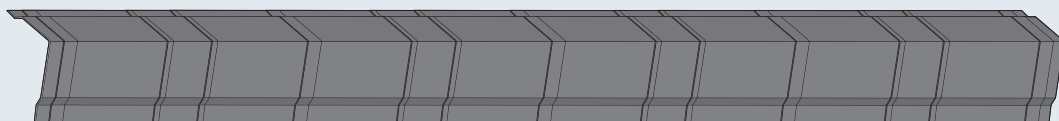
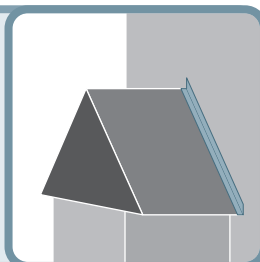
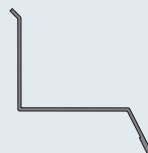
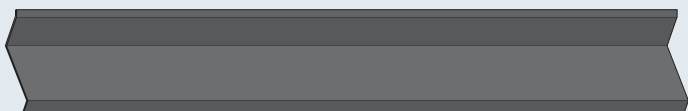
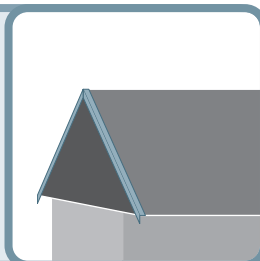
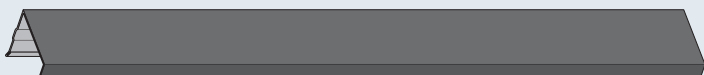
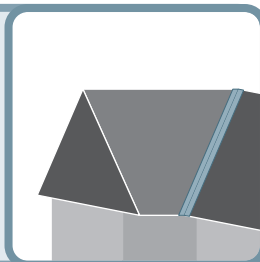
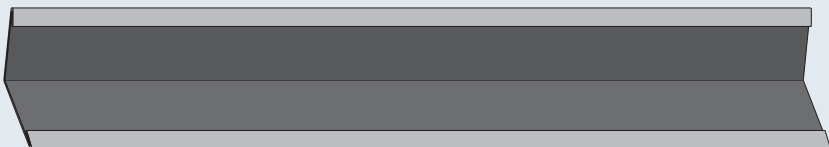
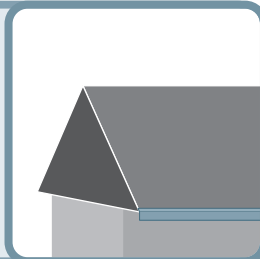
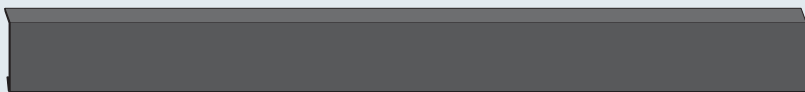
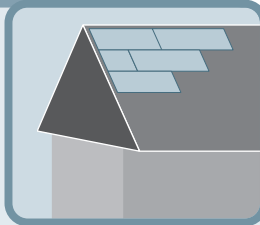
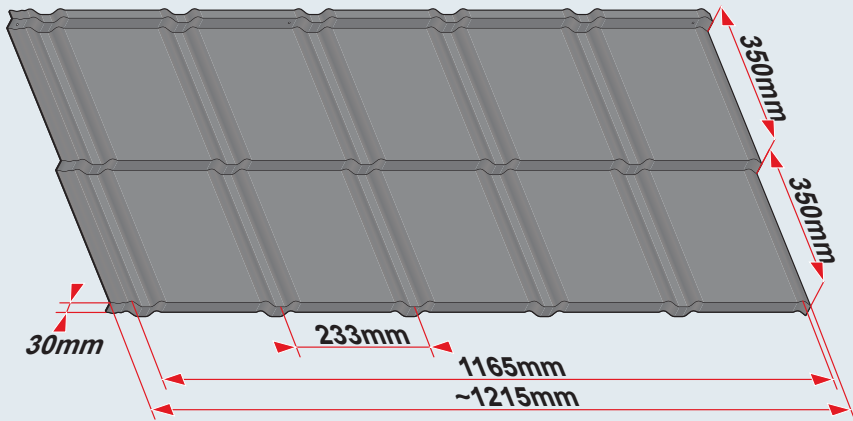

1

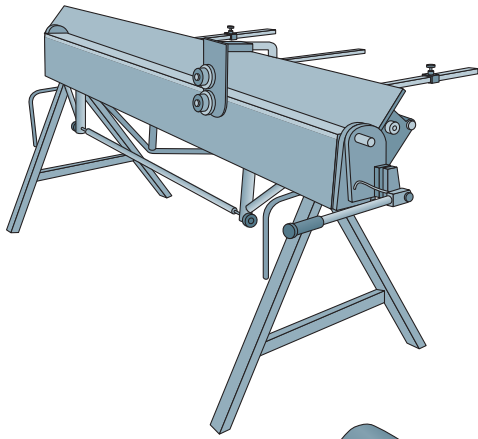

max 4000 r/min

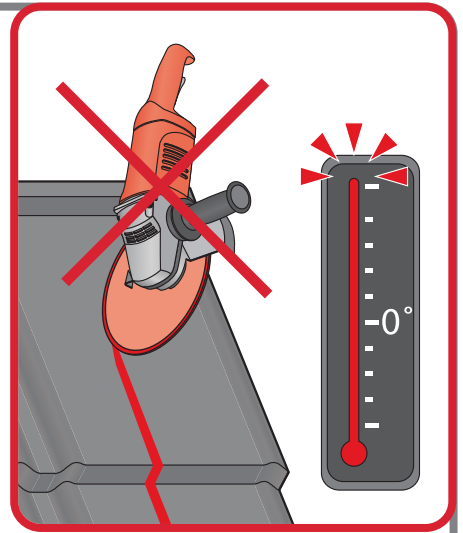
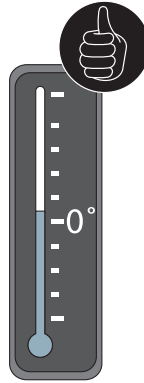
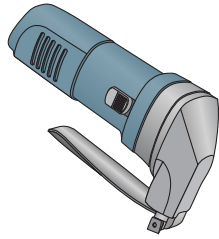

2

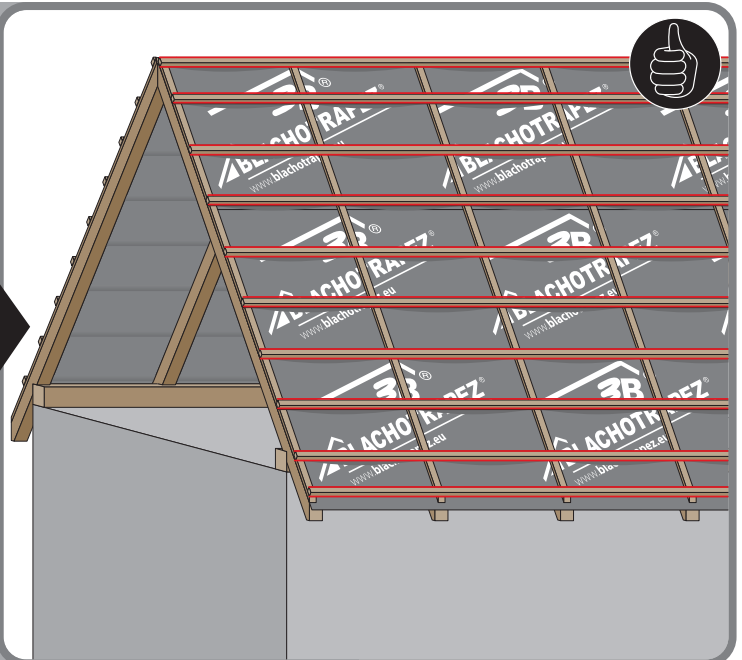
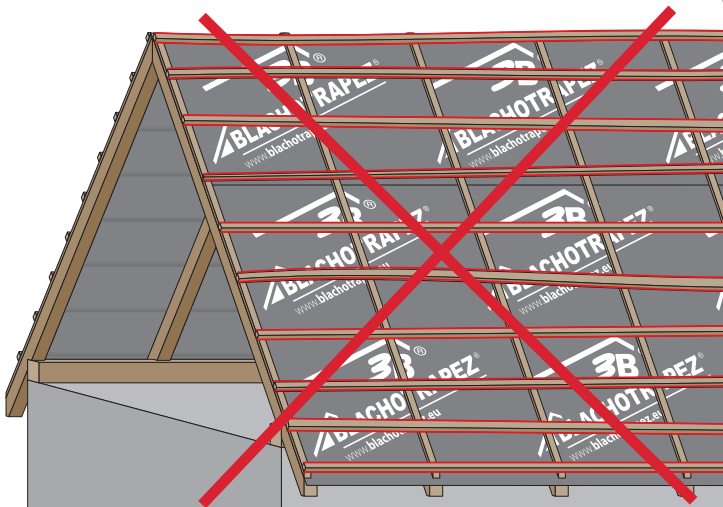
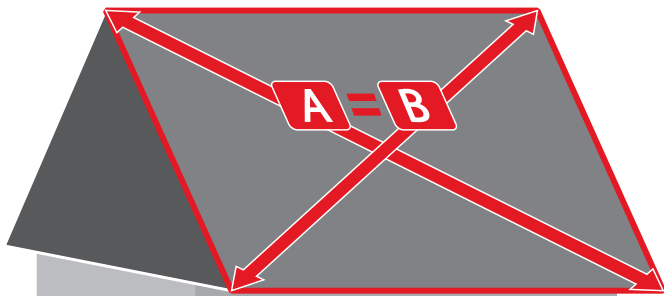

3

3a

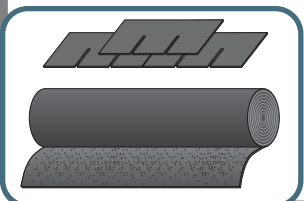
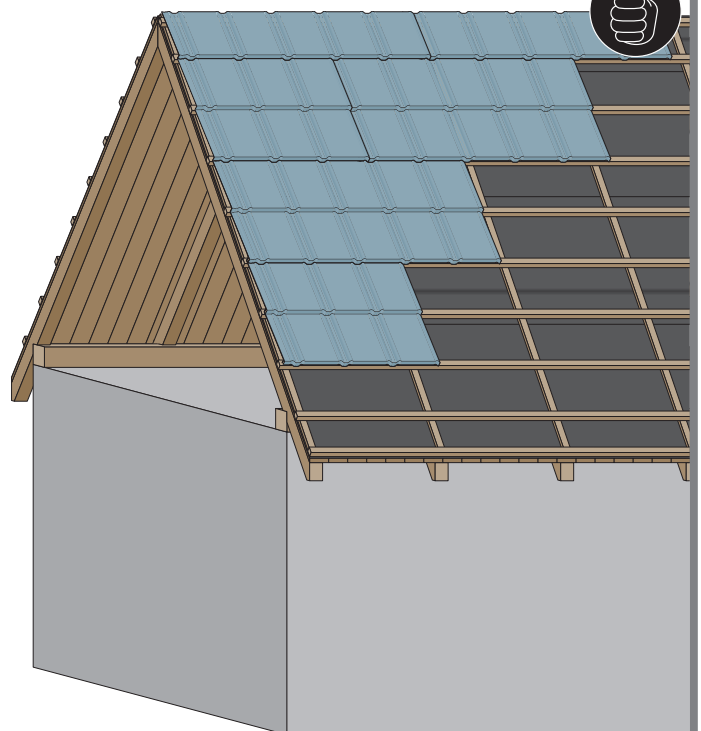
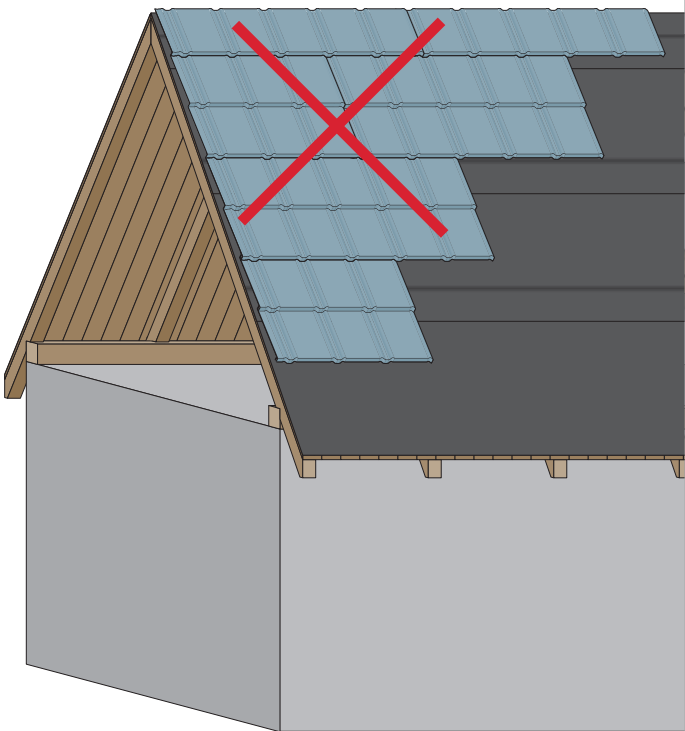
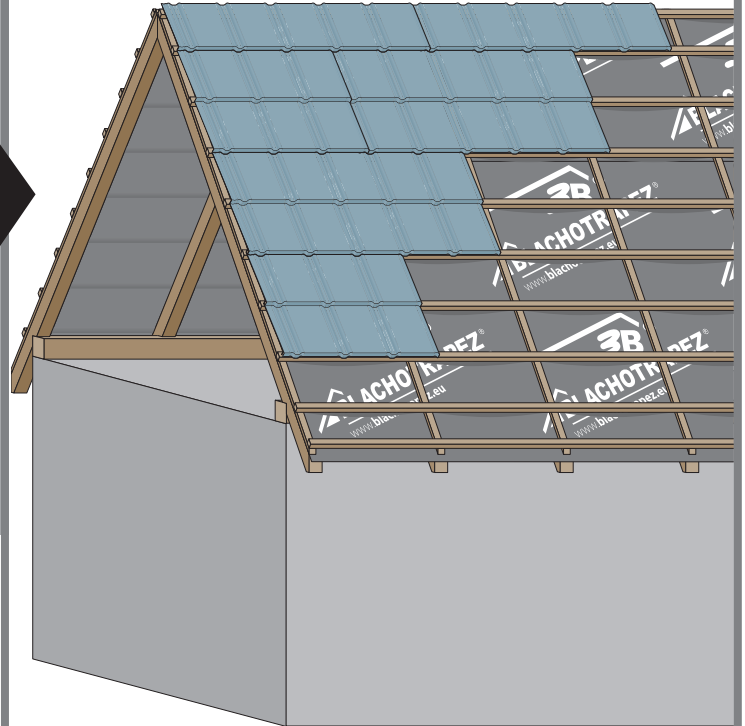
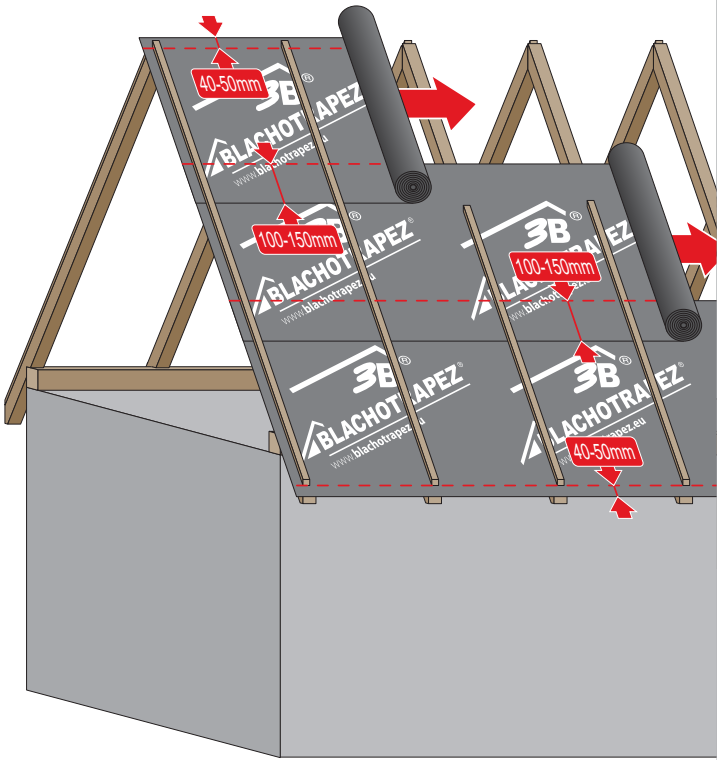

3b

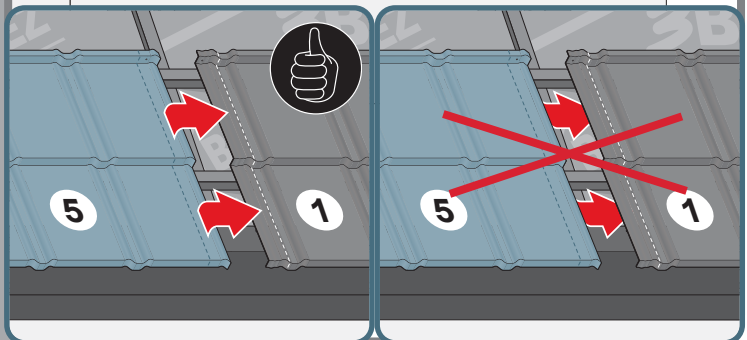
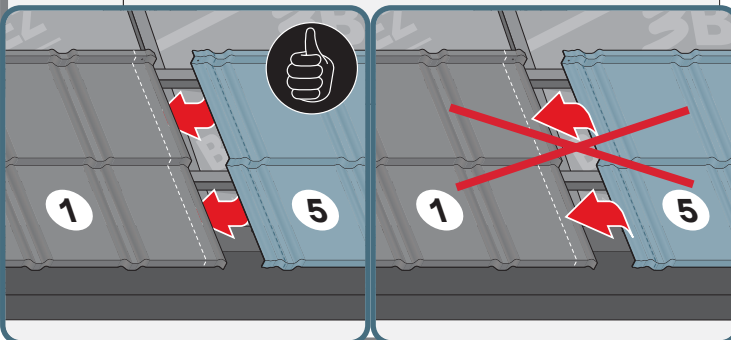
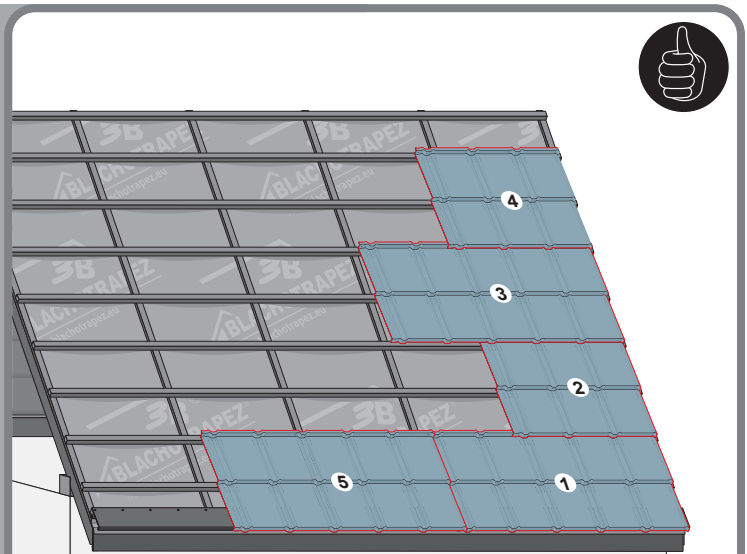
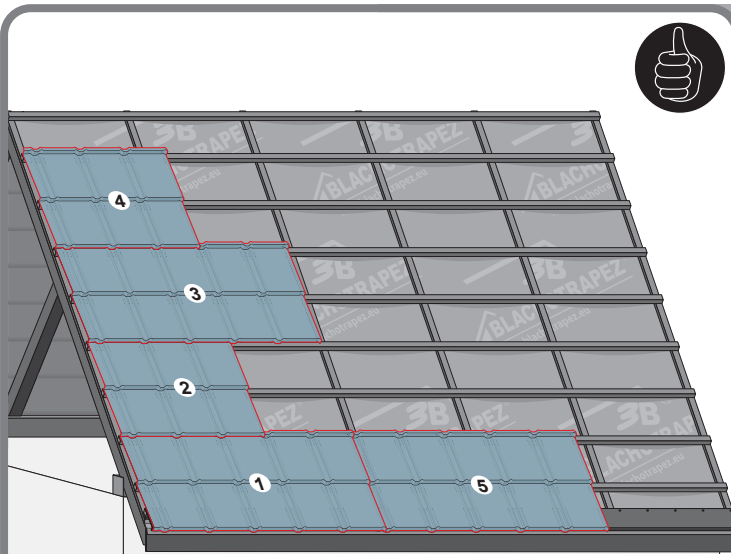
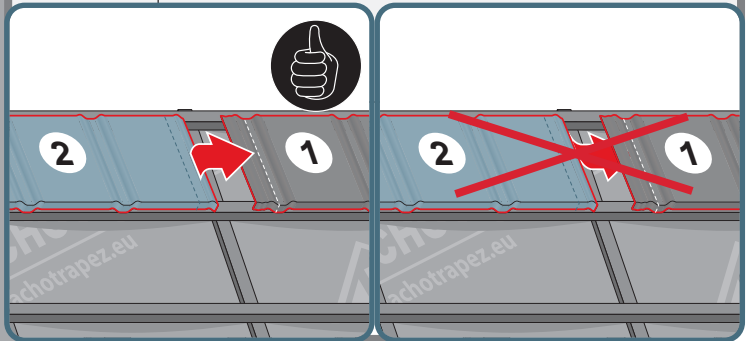
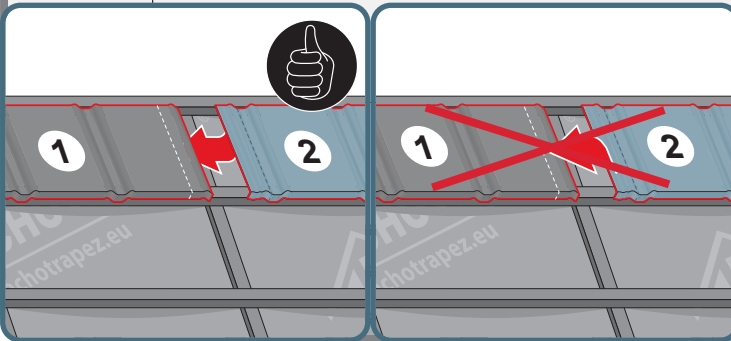
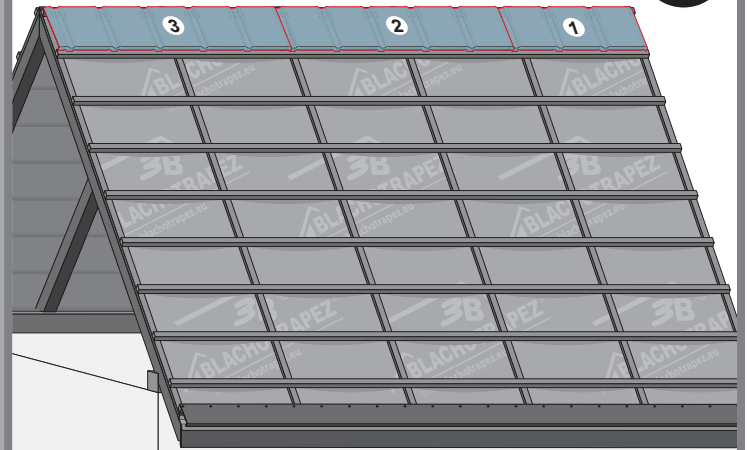
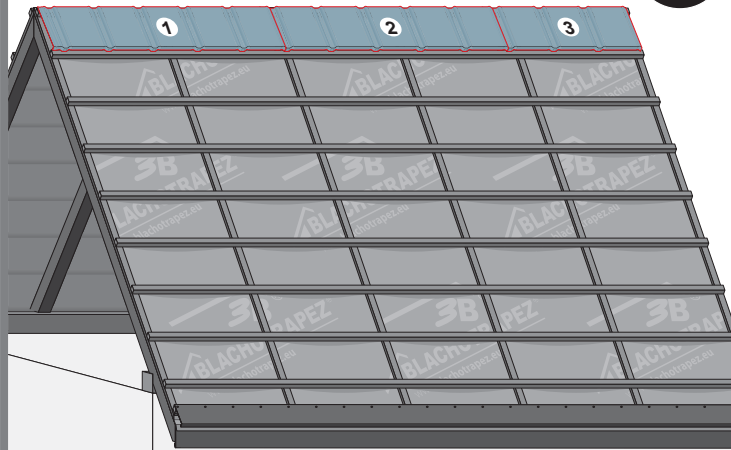

3c

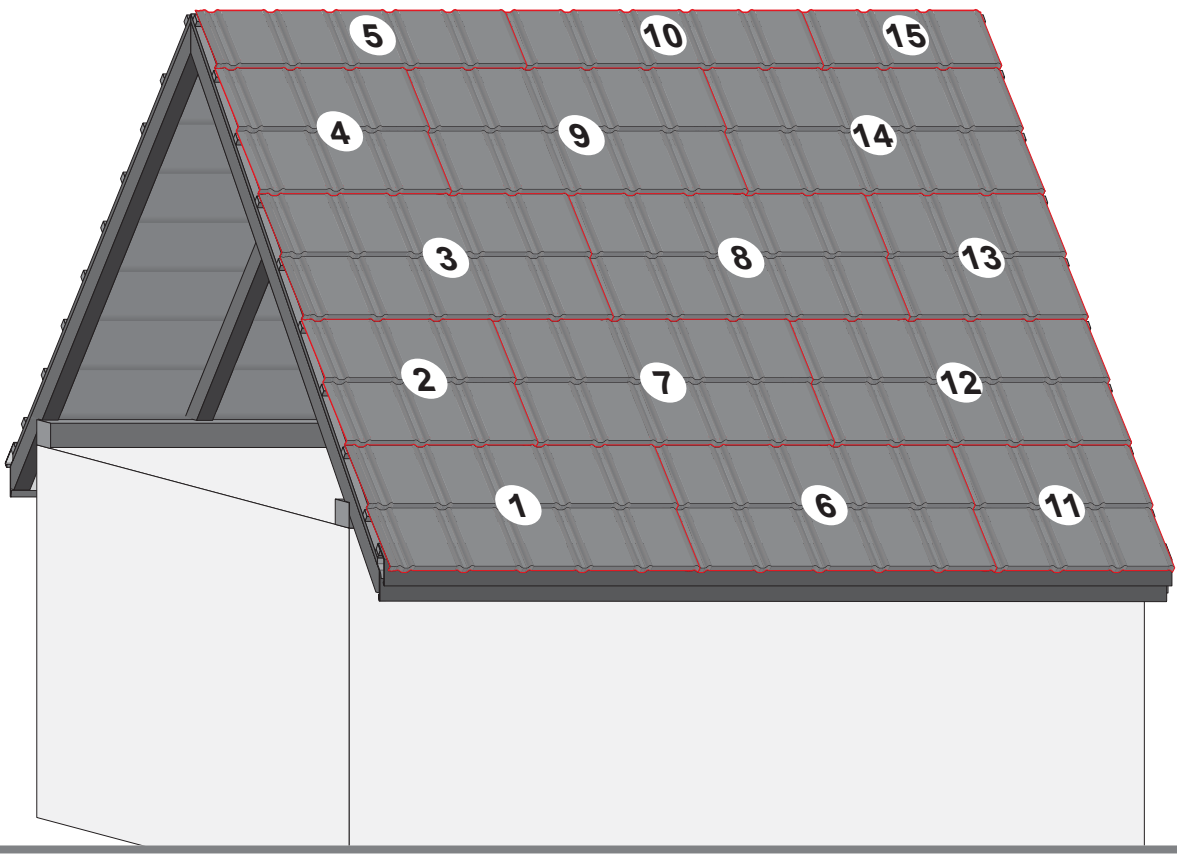
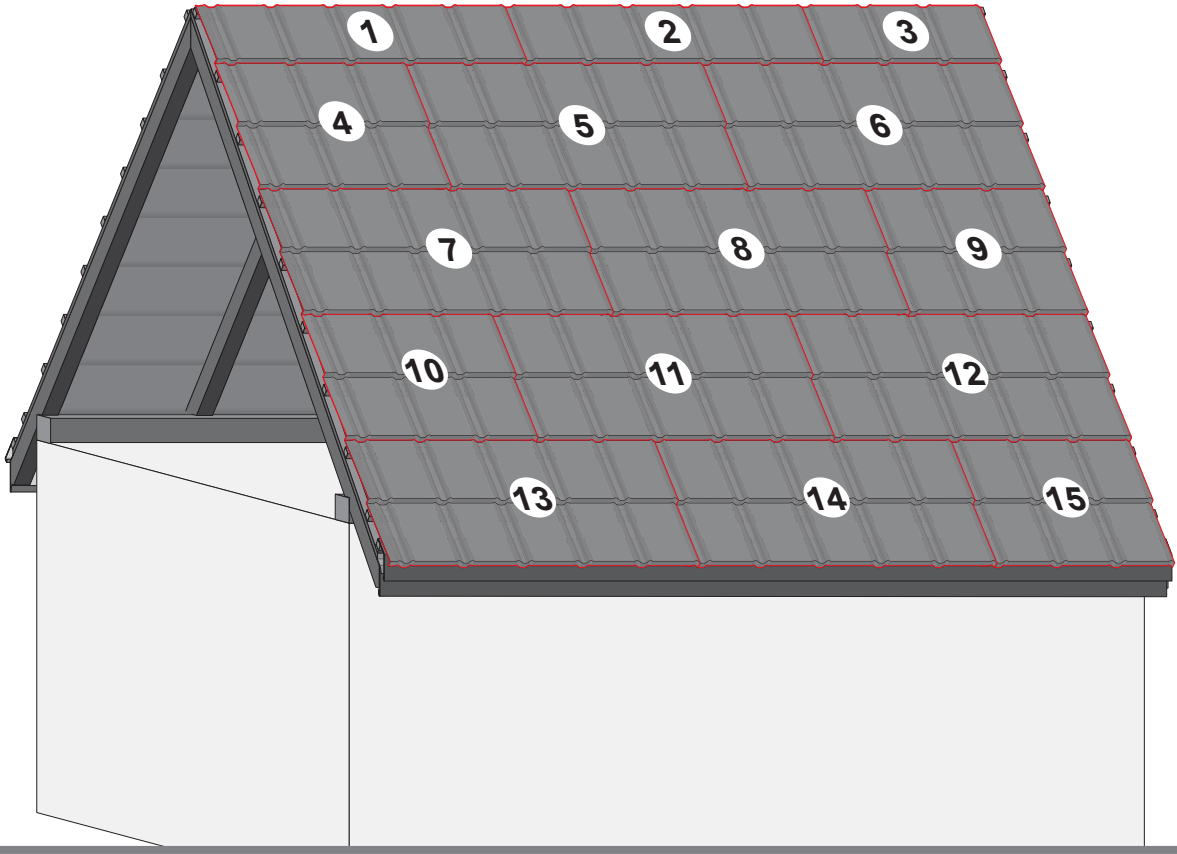

4

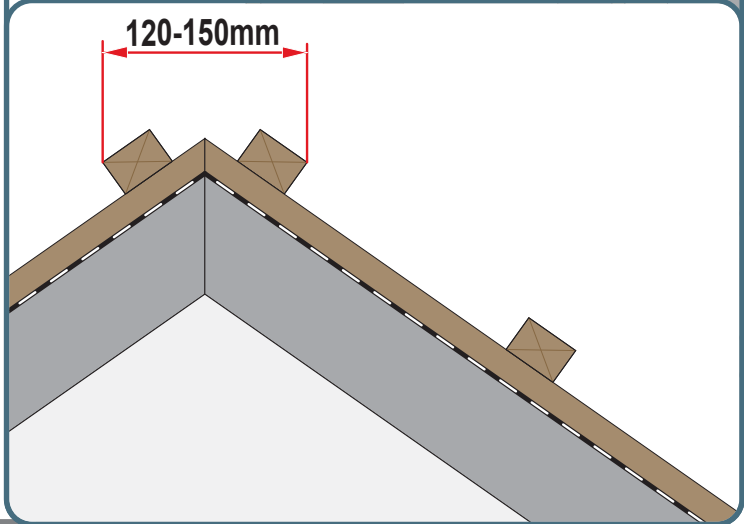
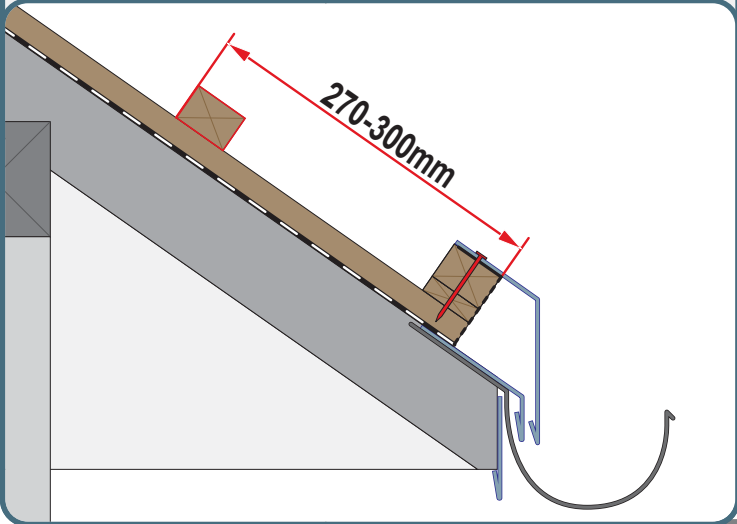
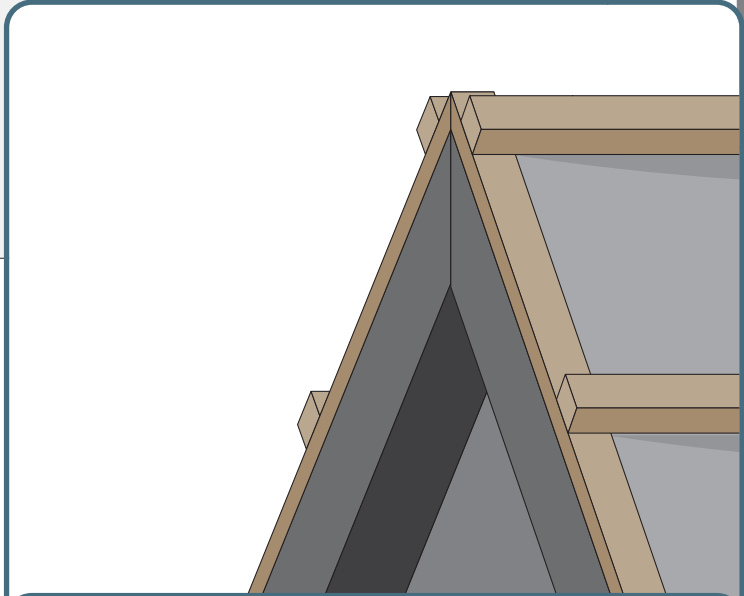
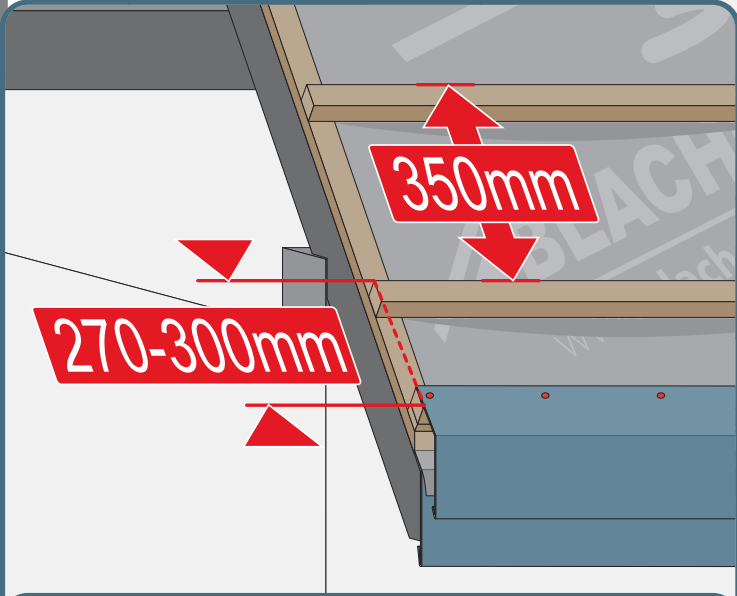
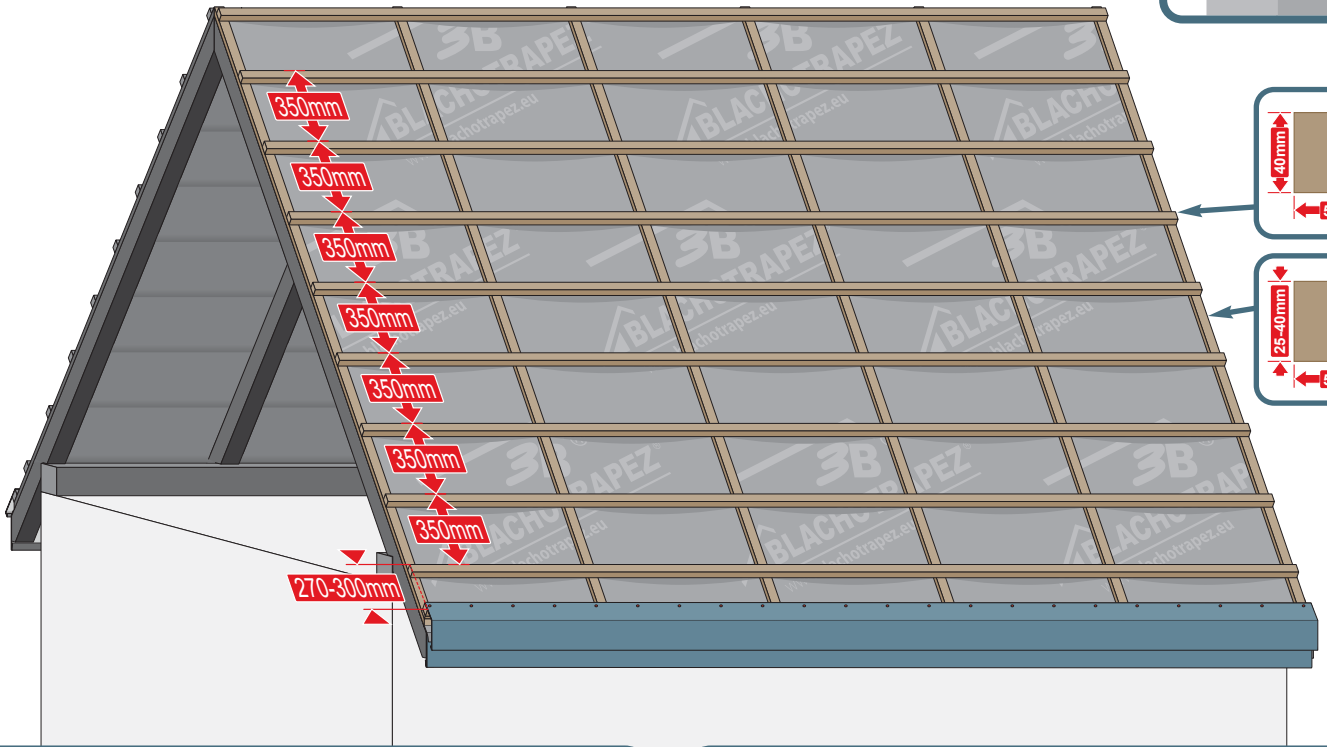

5a

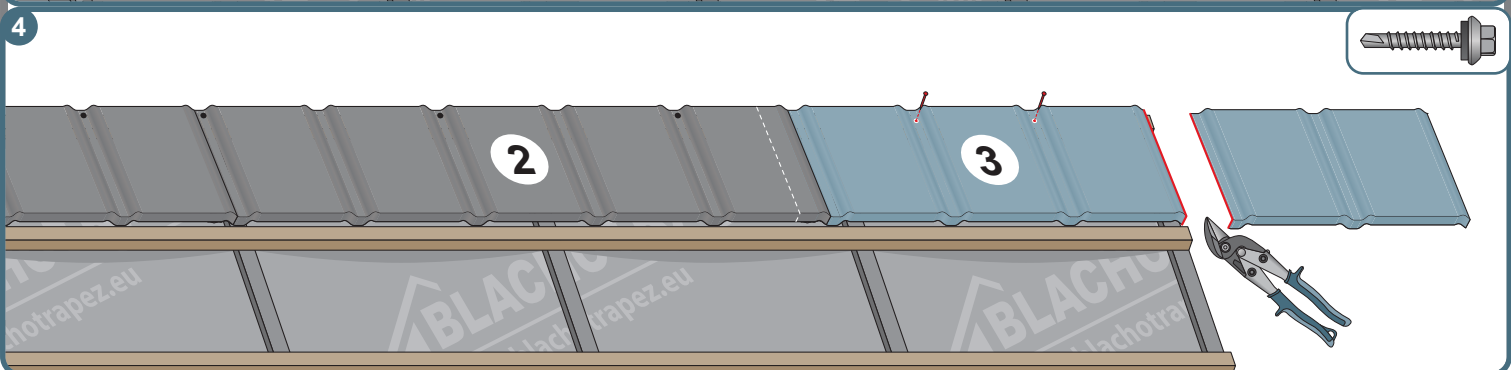
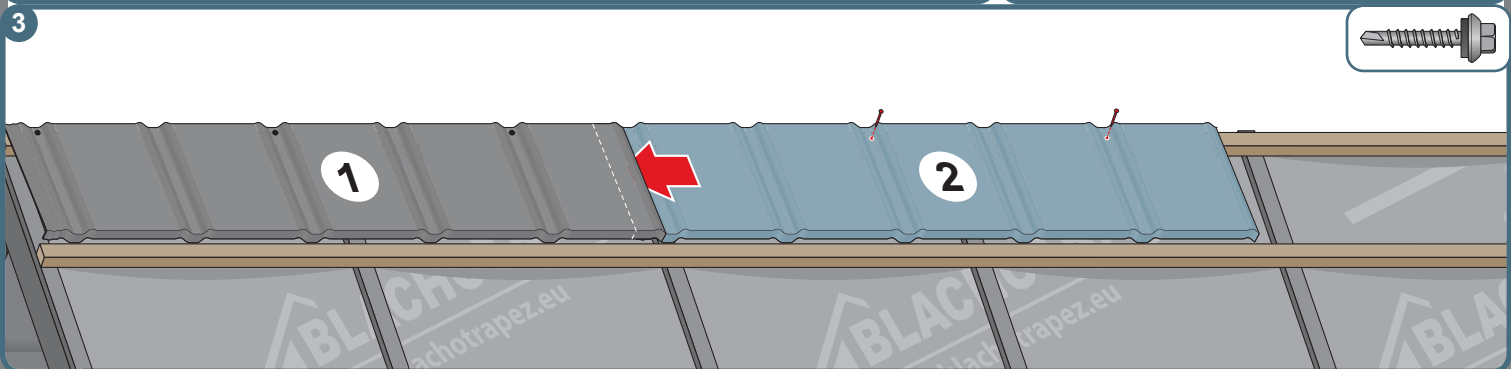
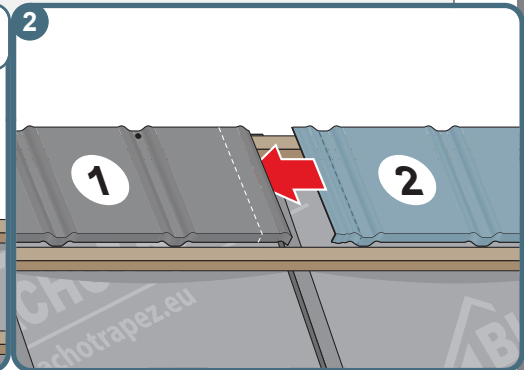
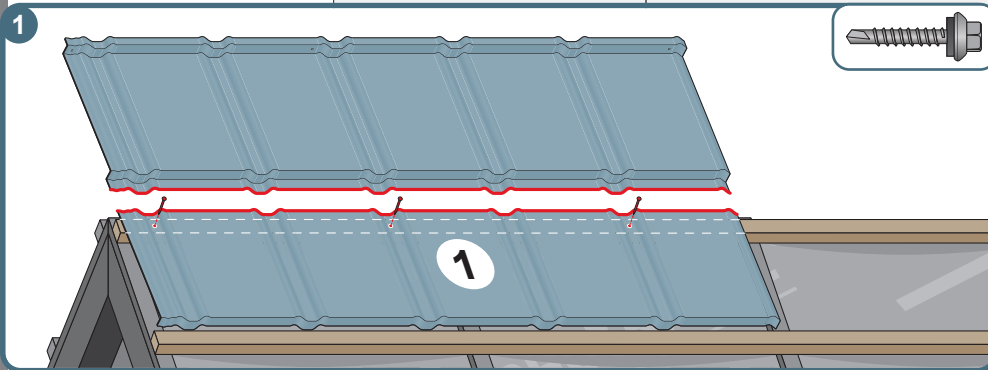
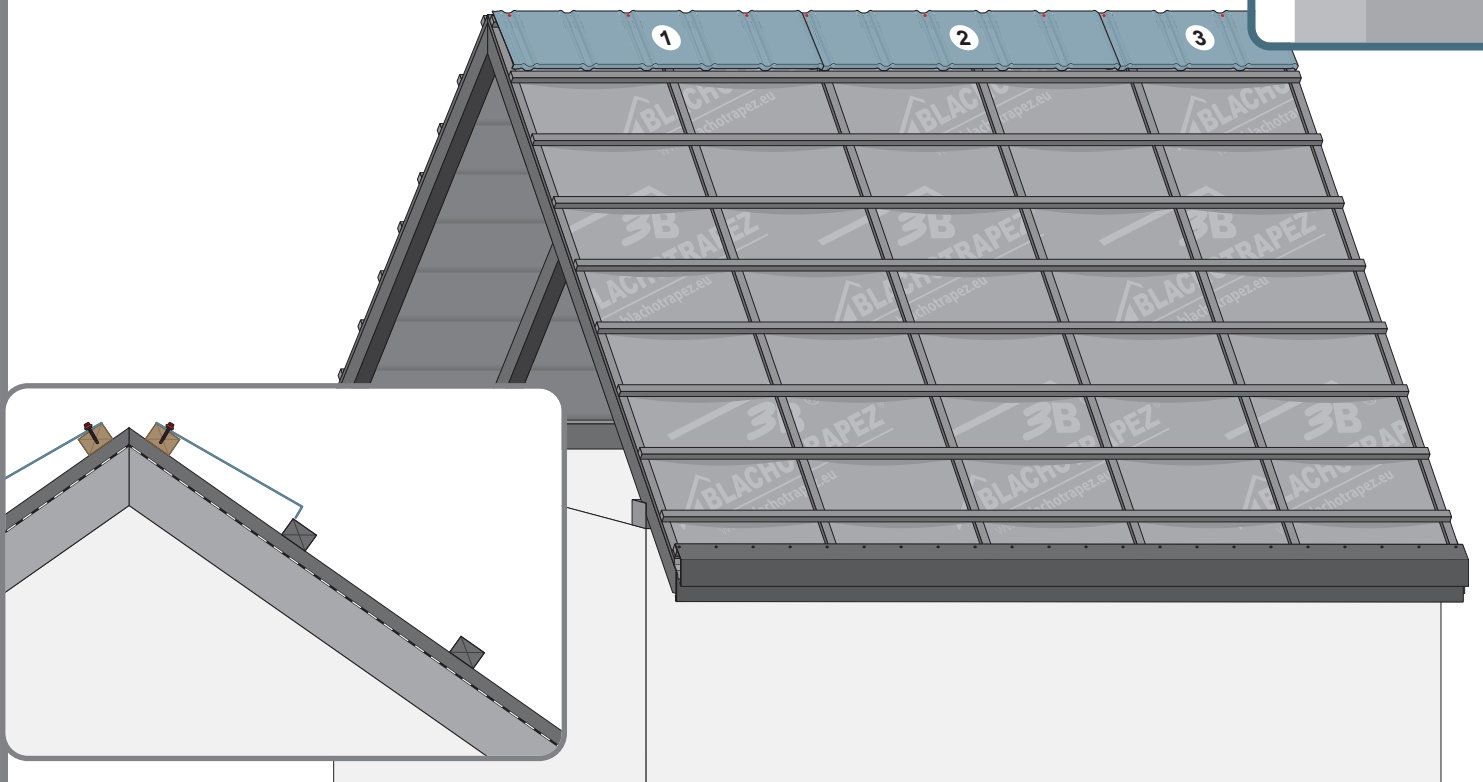
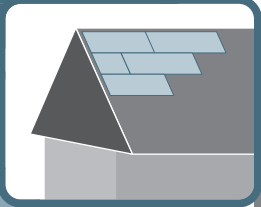



5b

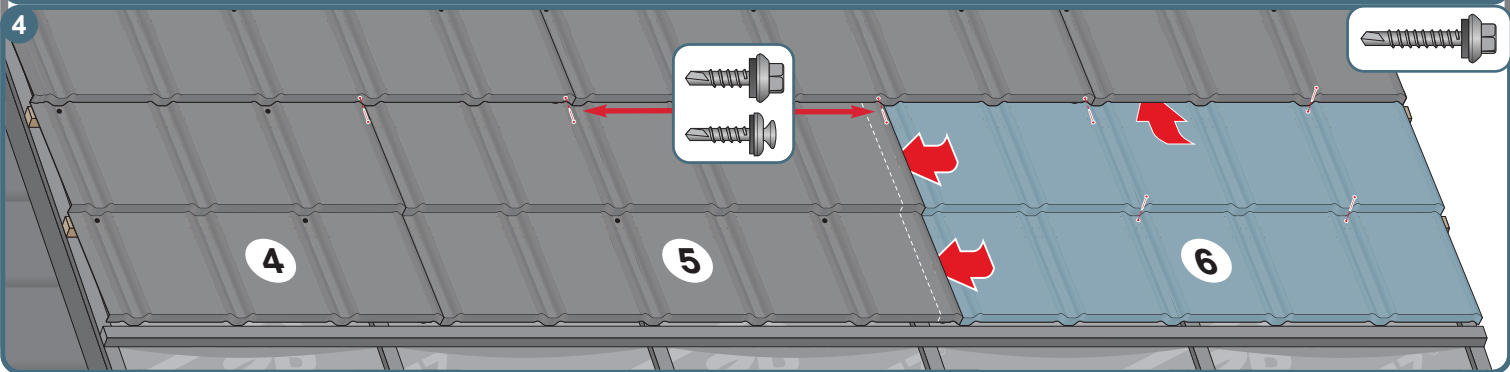
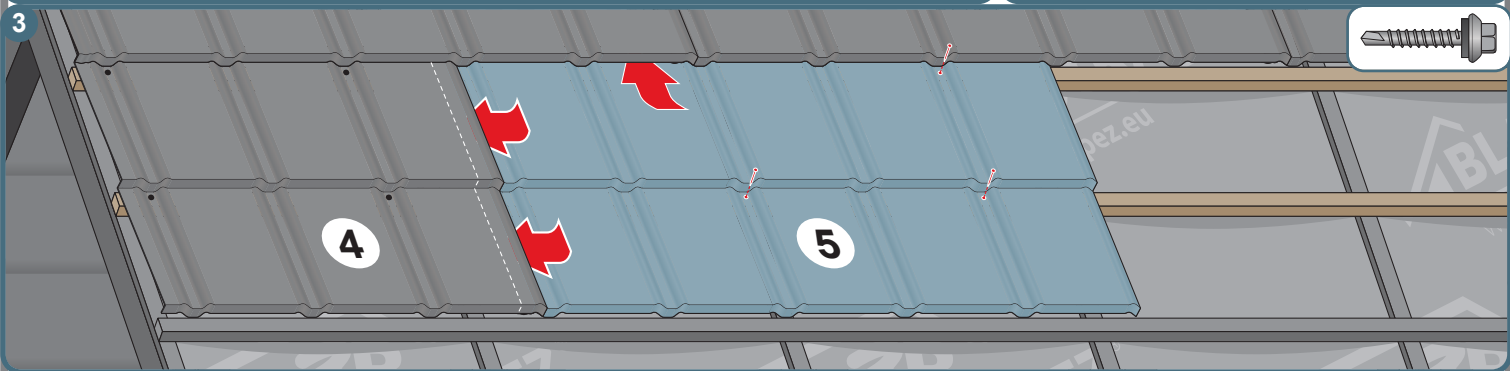
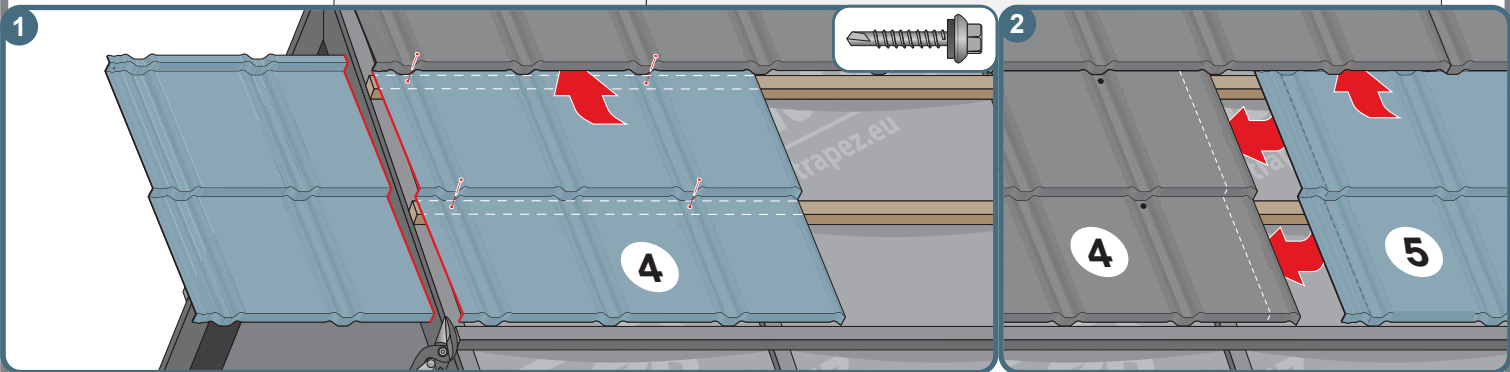
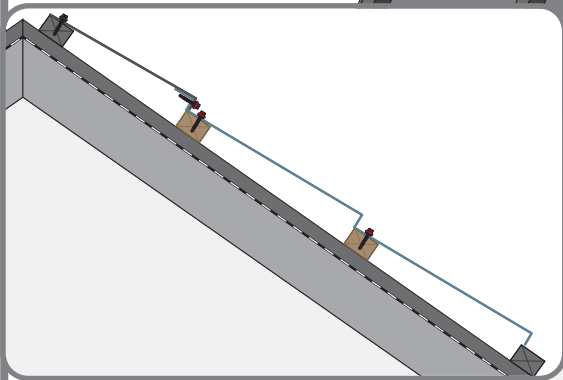
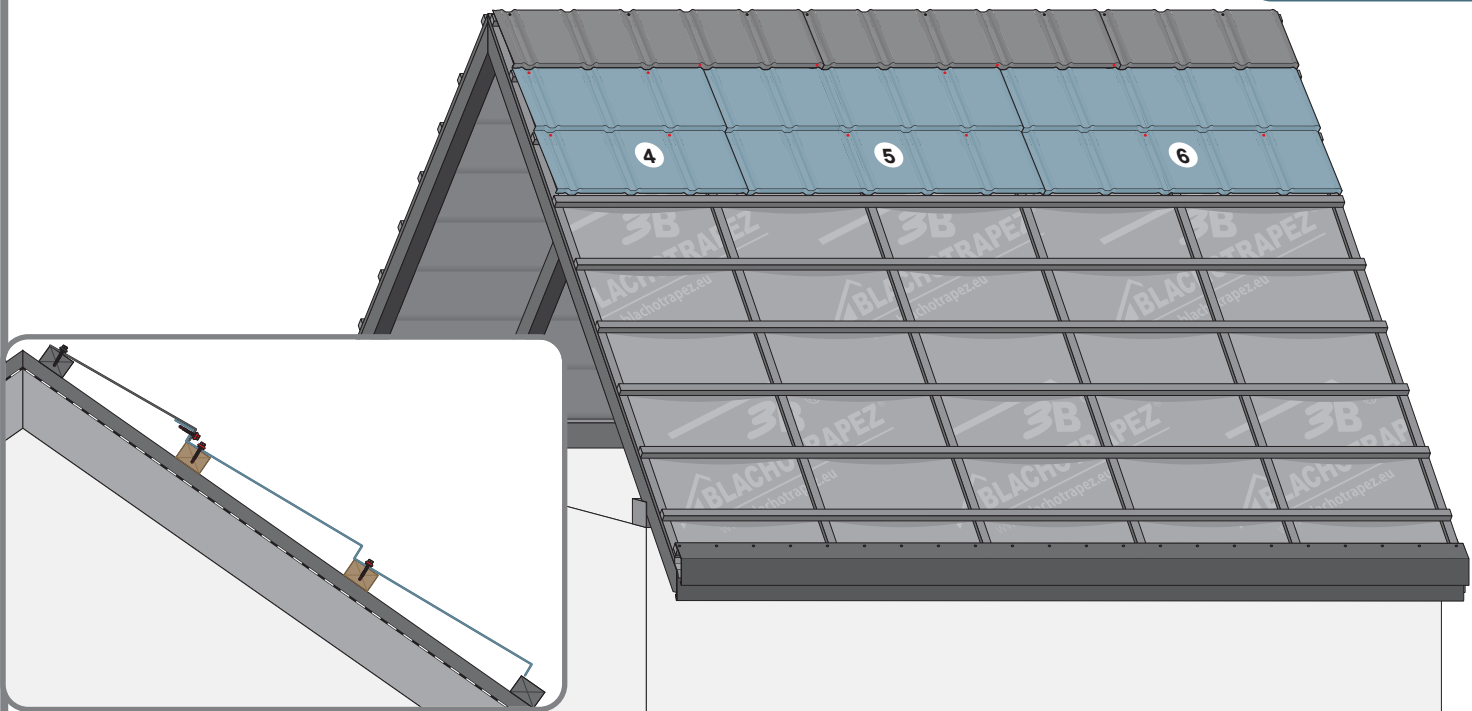
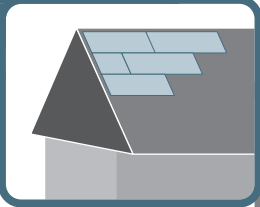

5c

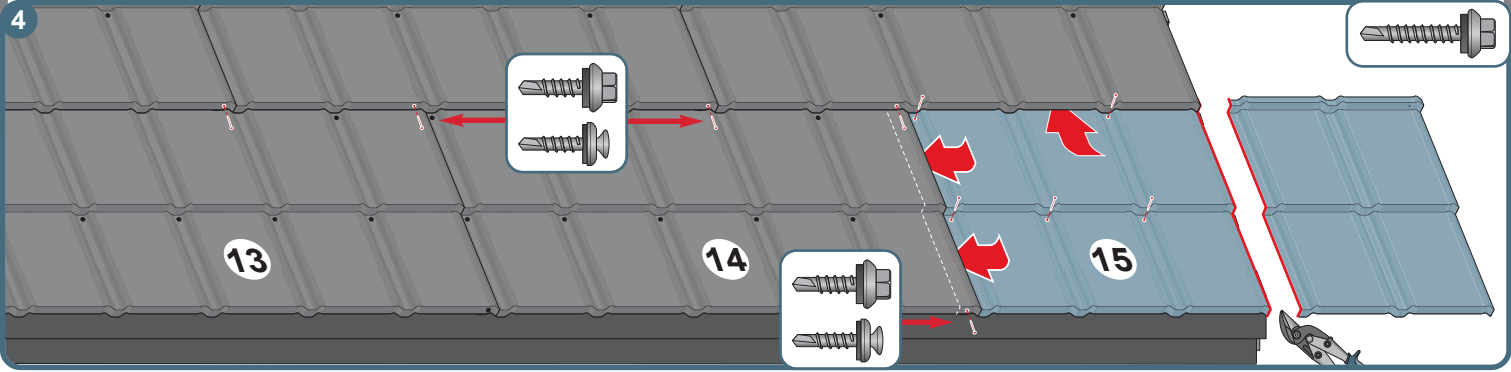
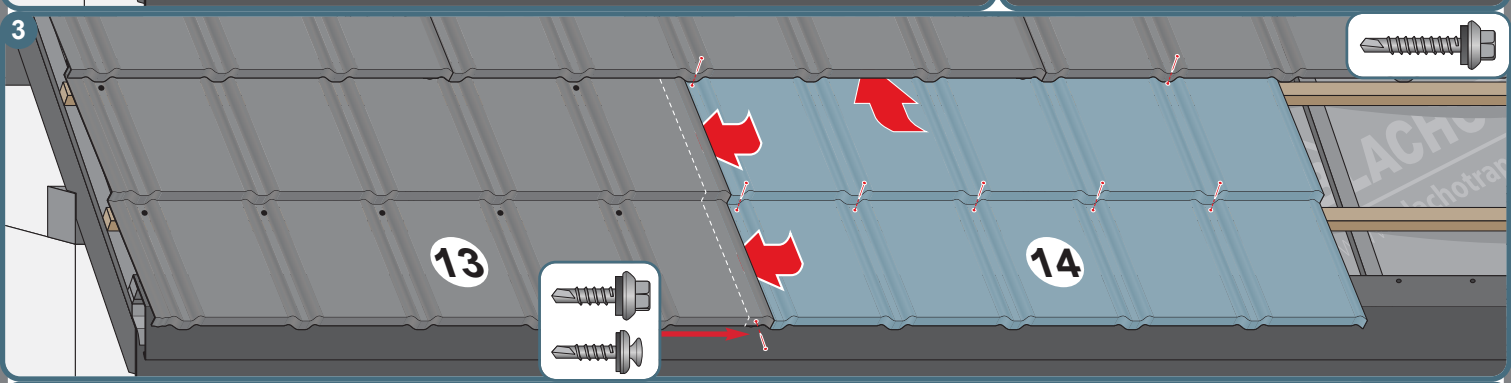
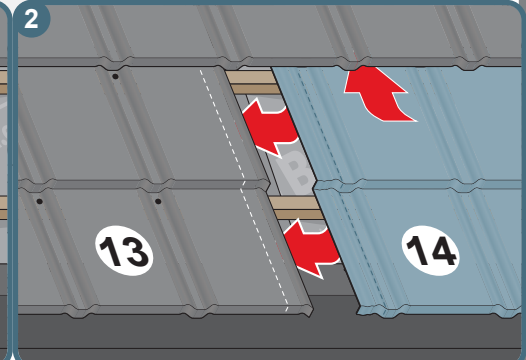
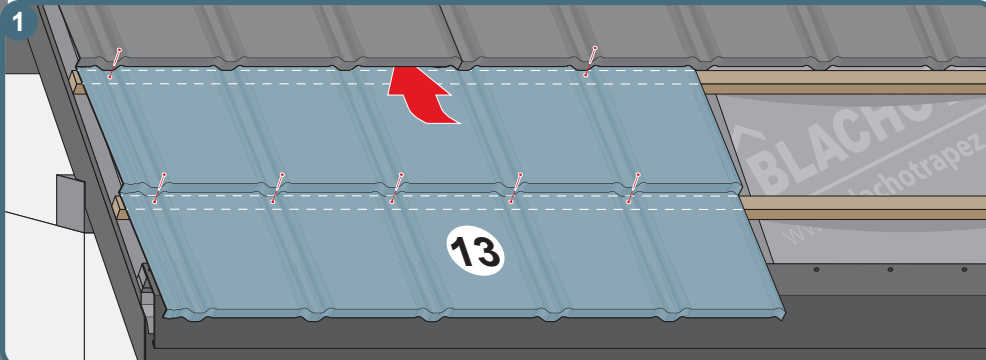
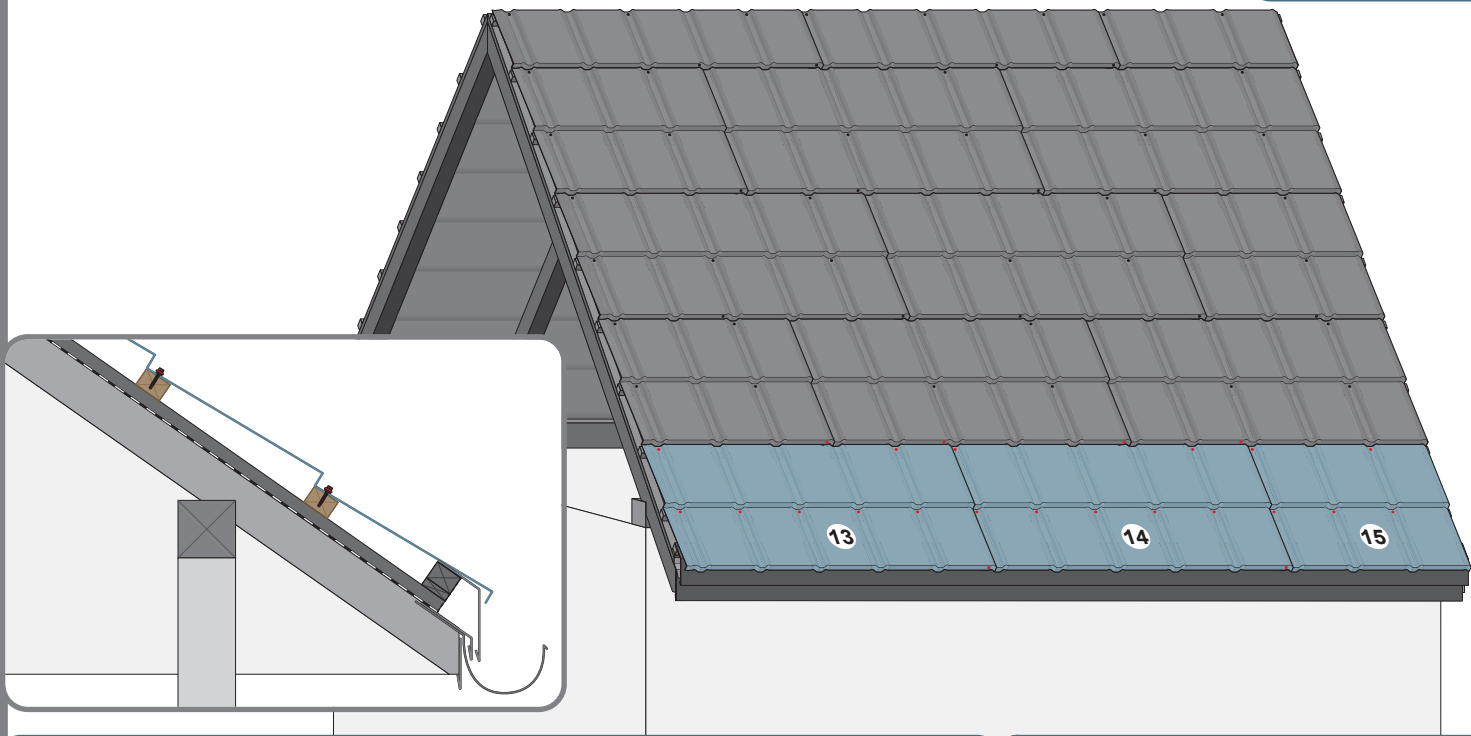
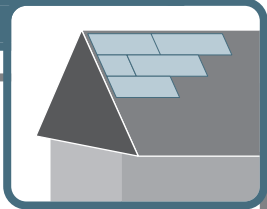

5d

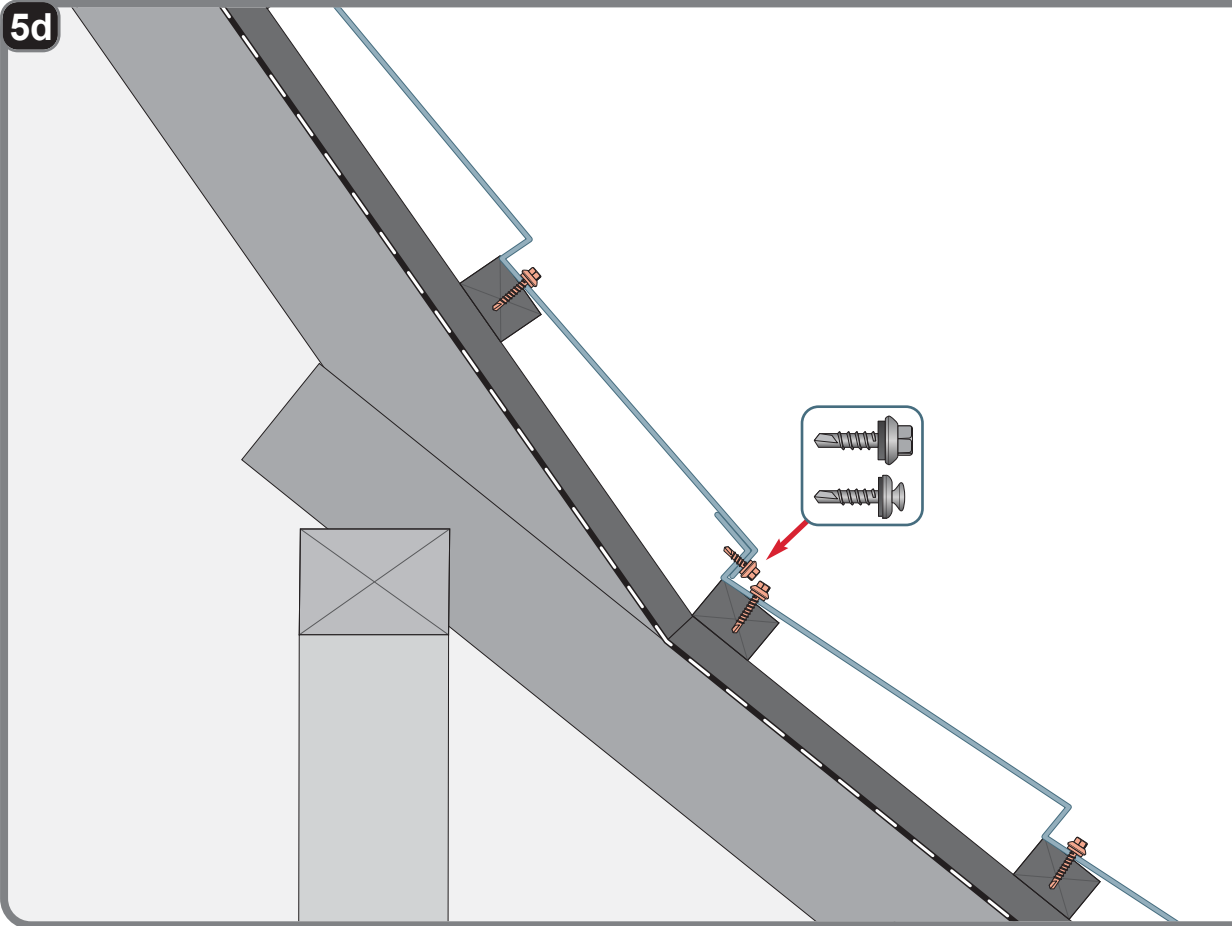
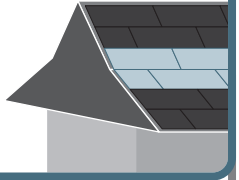

5e

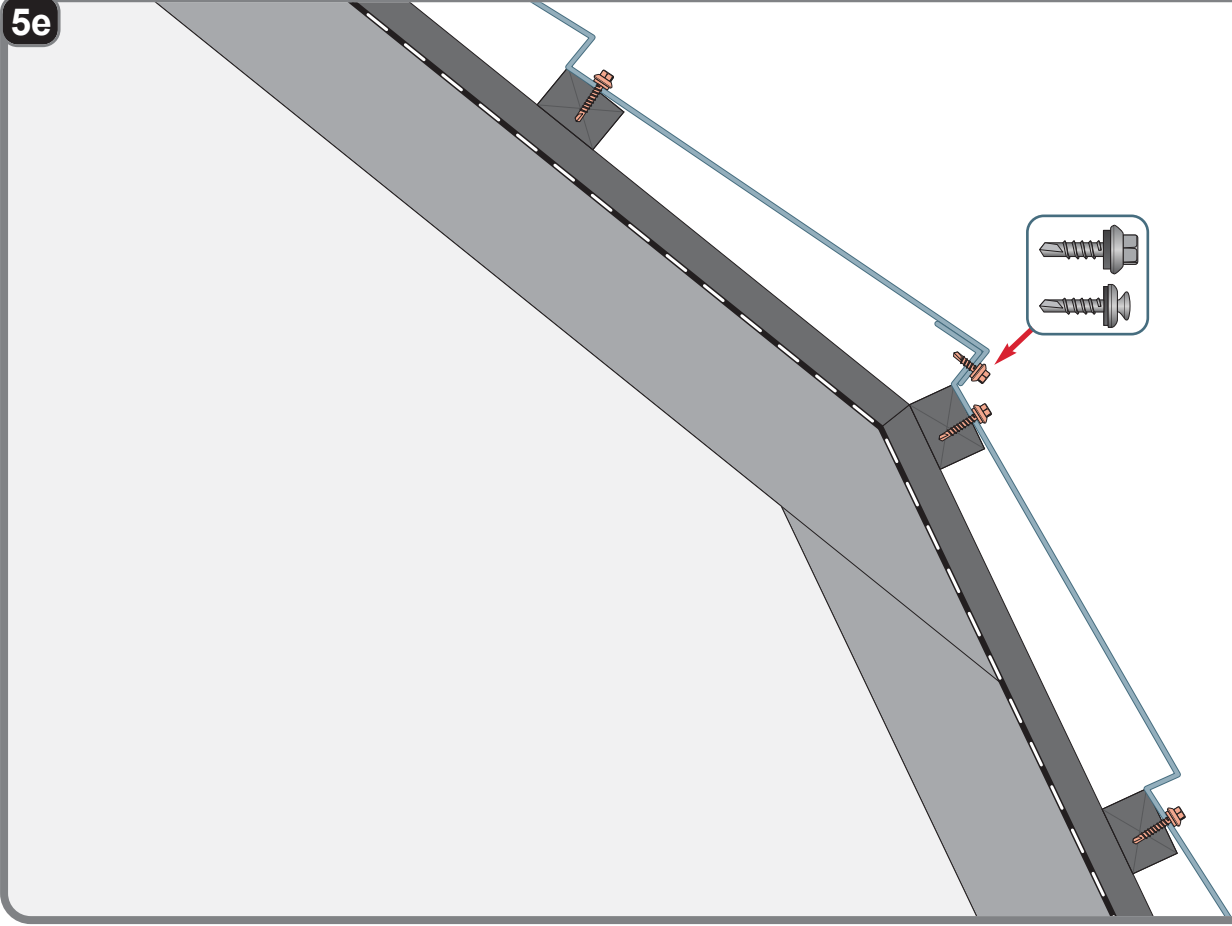
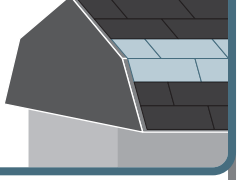

6a

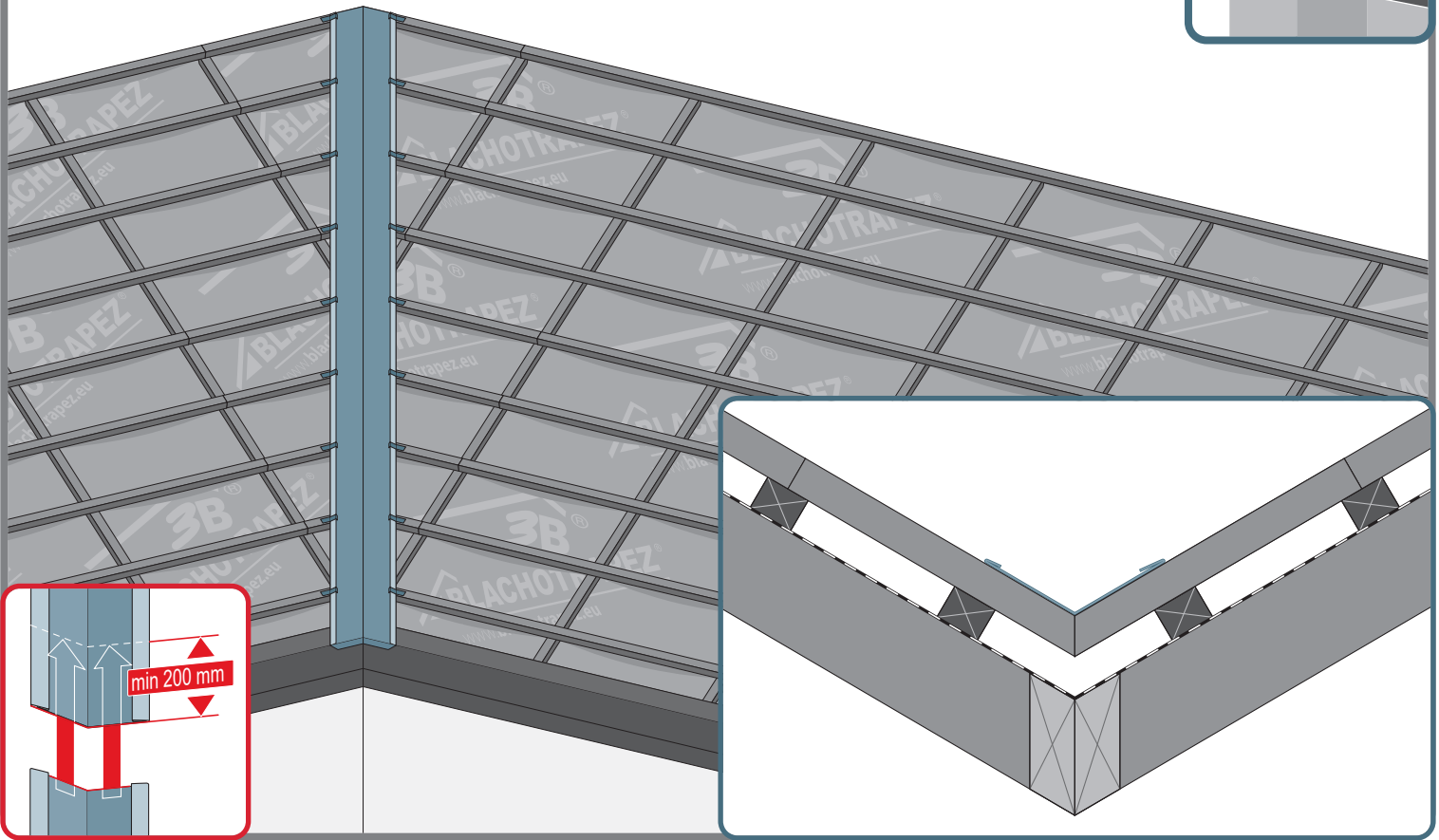

6b

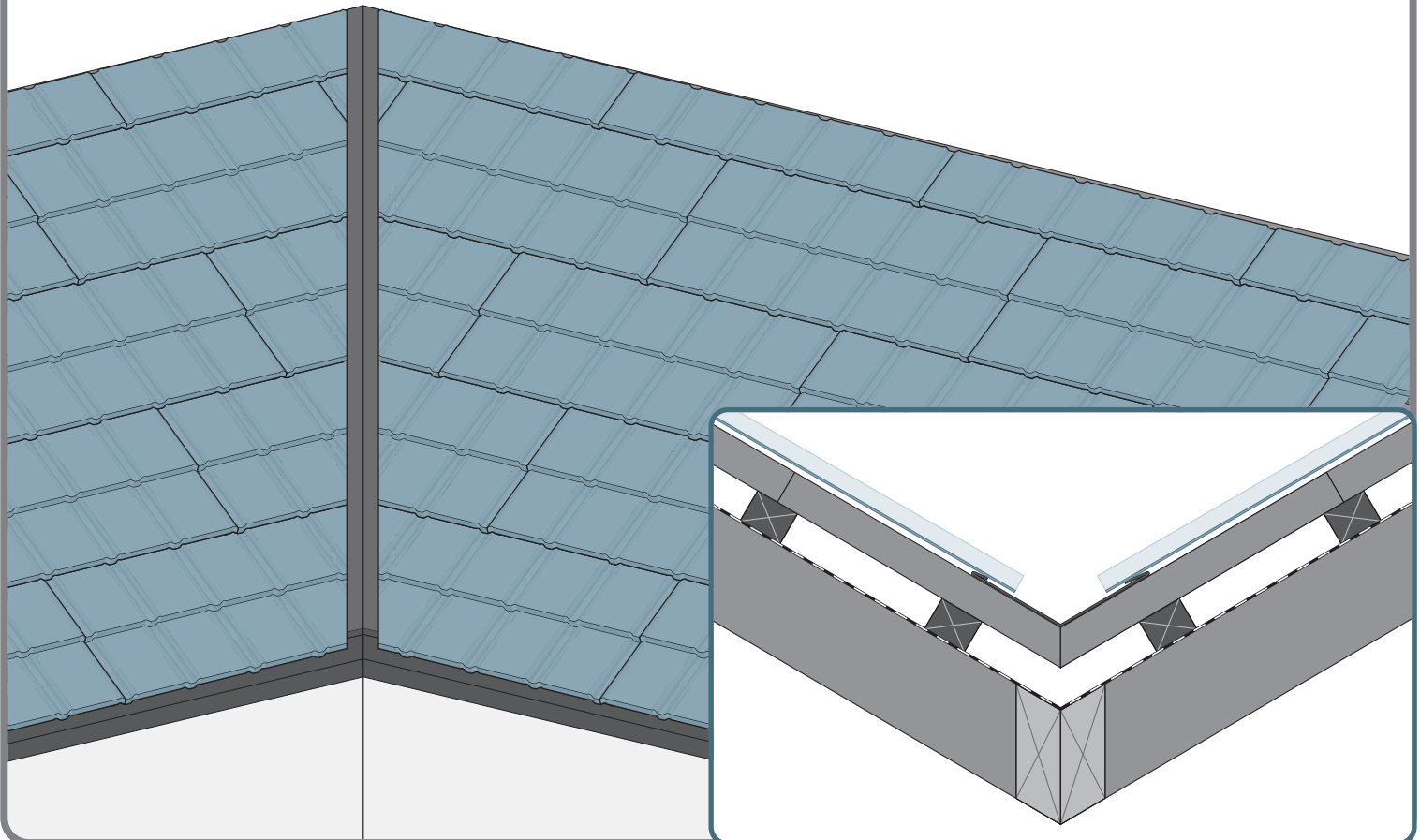

7a

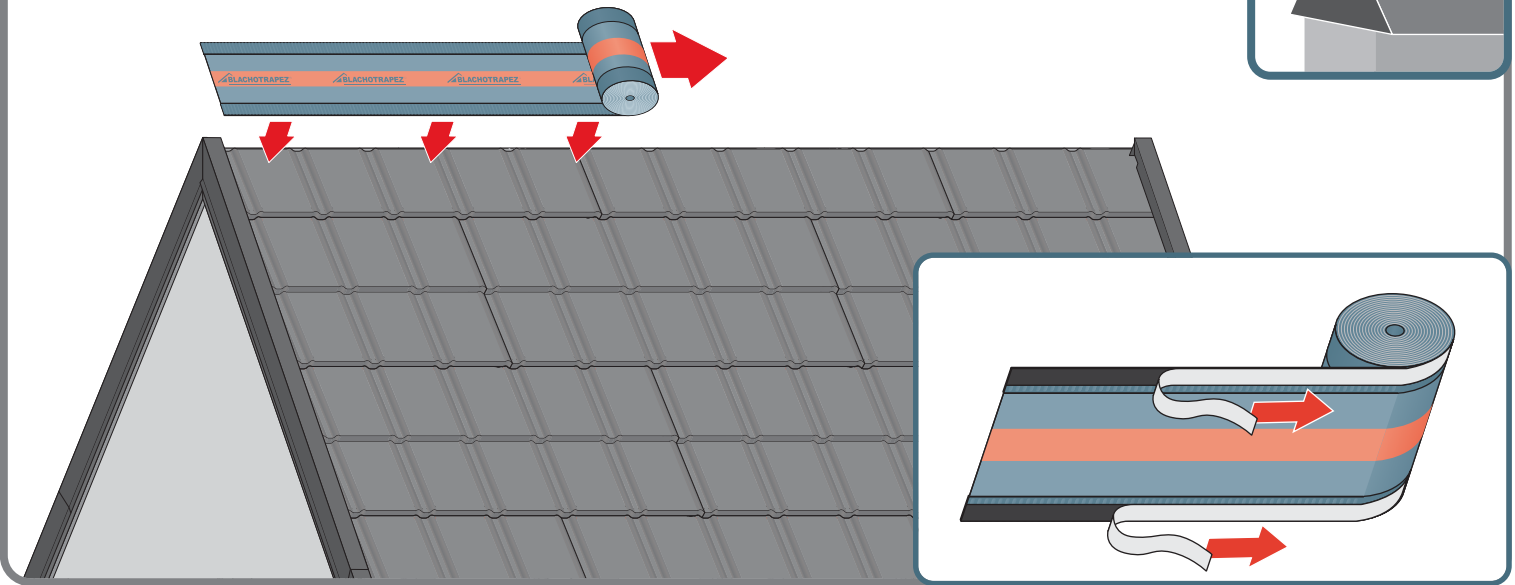

7b

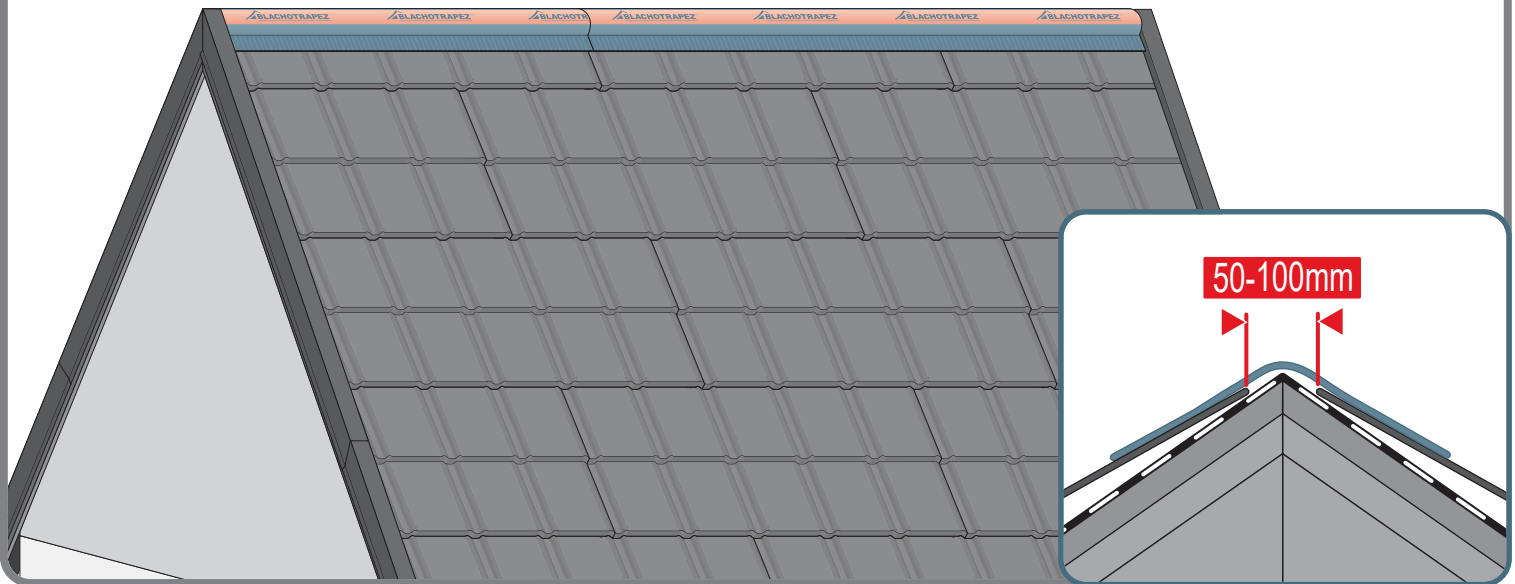

7c

