

Montageempfehlung

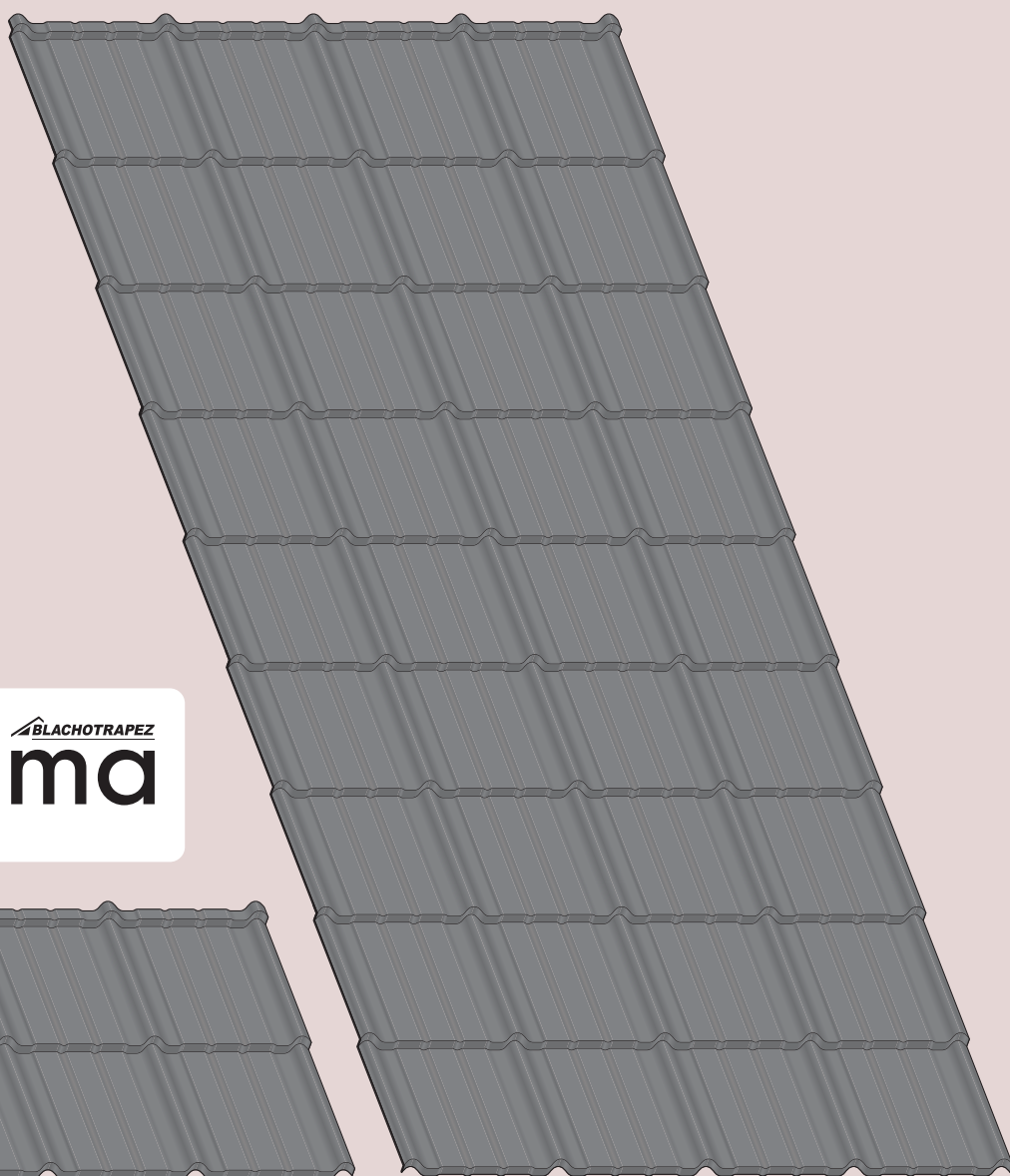

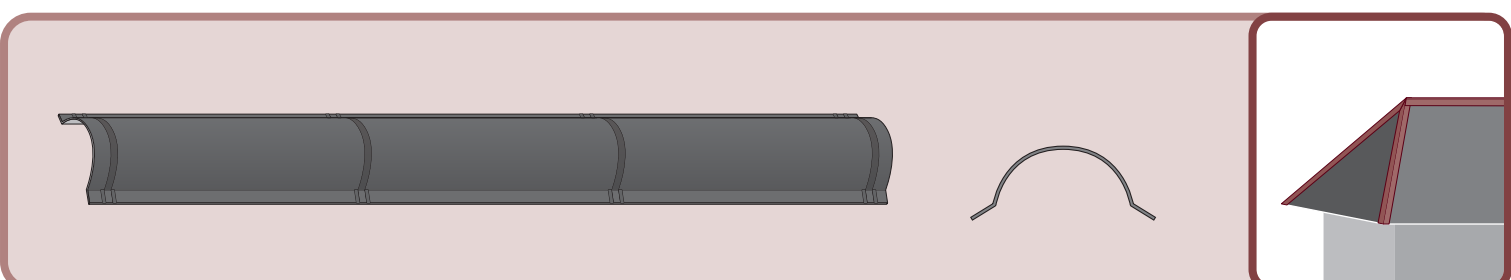

1

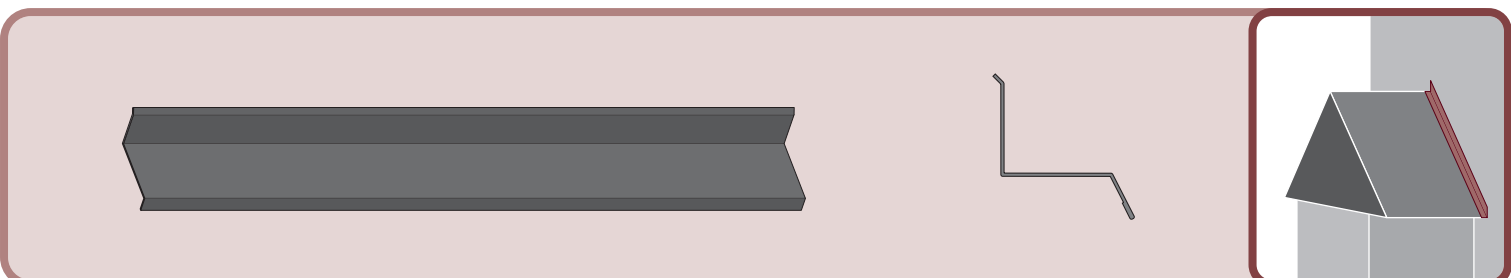
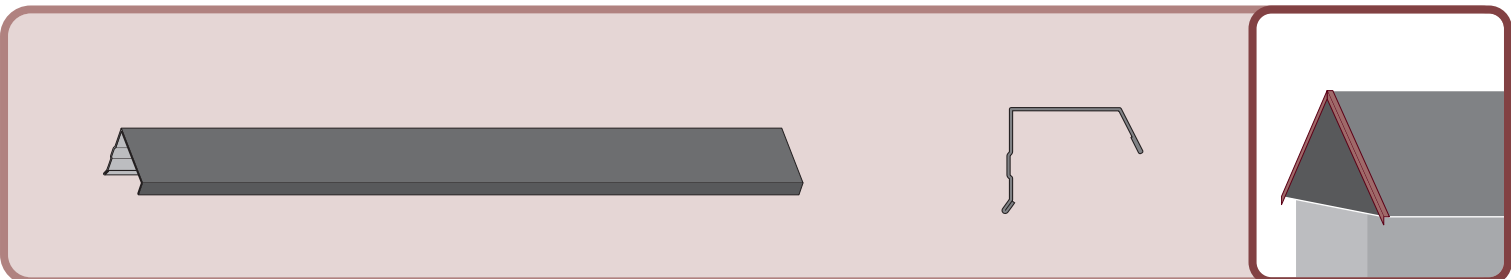
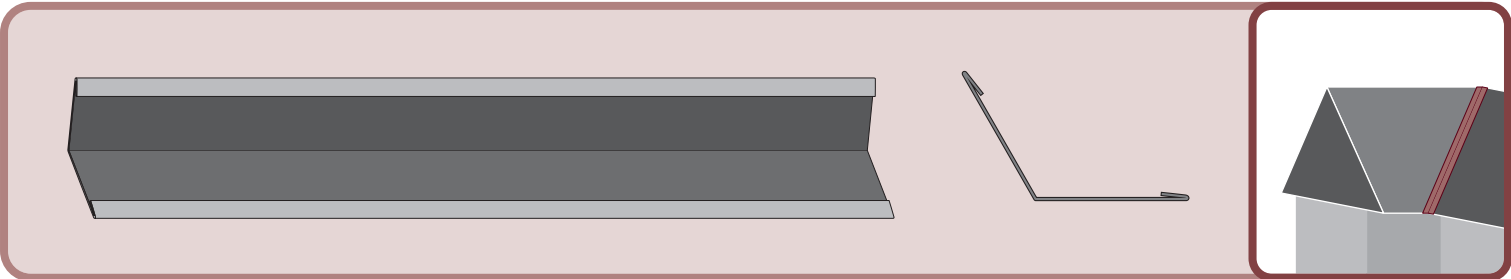
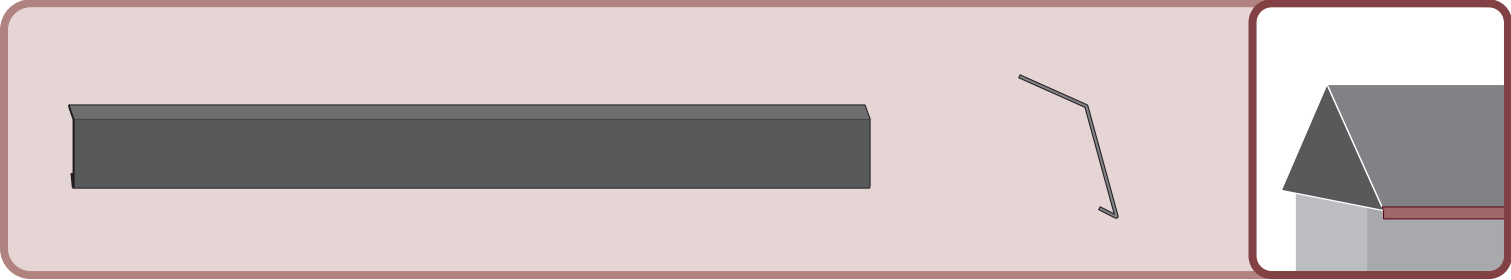
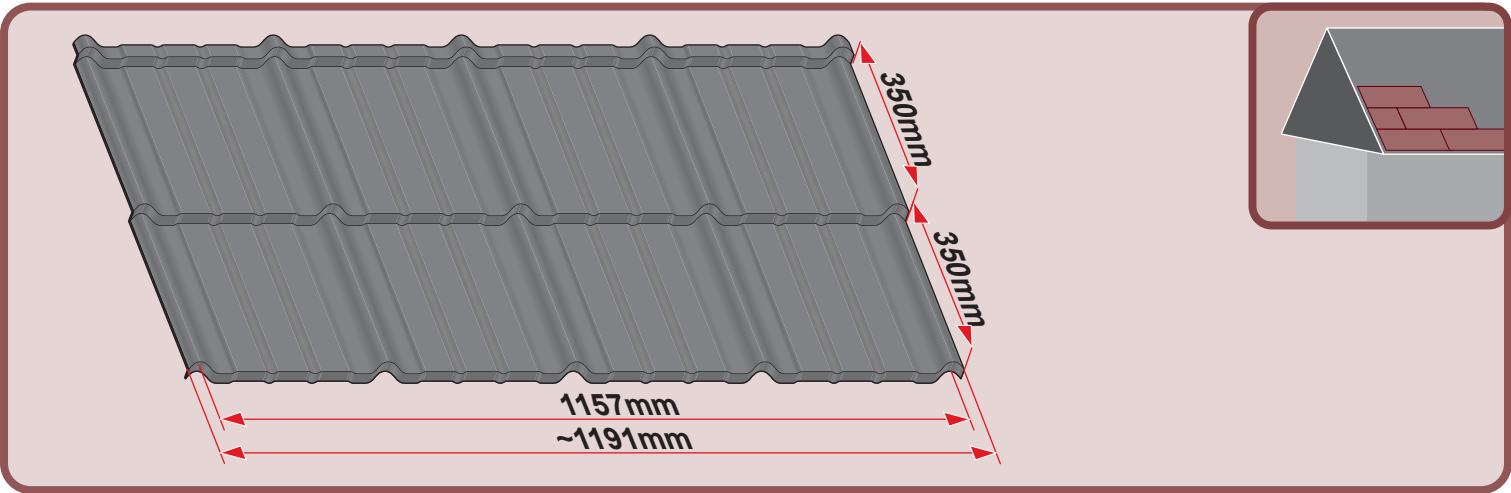
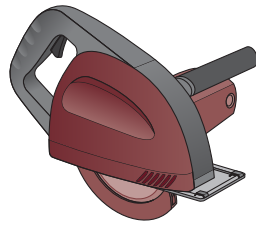
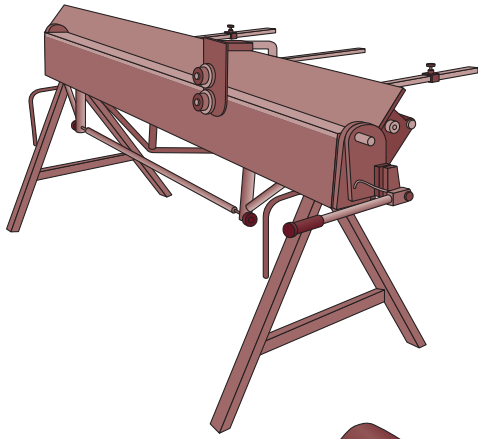

max 4000 r/min

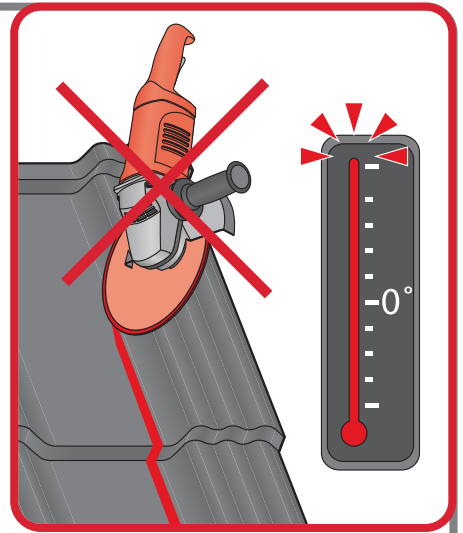
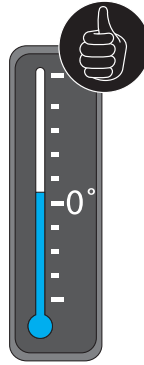
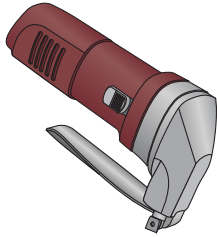

2

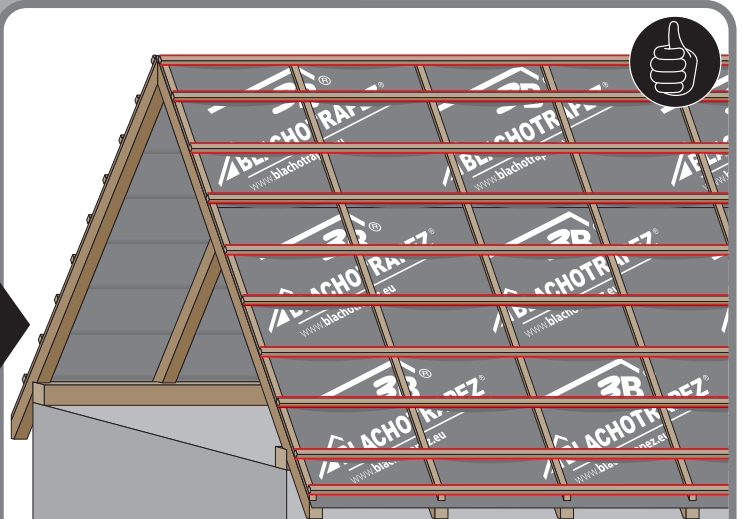
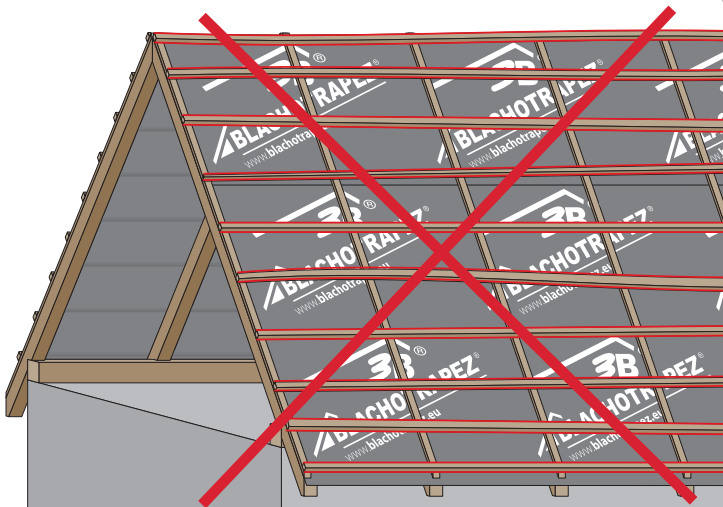
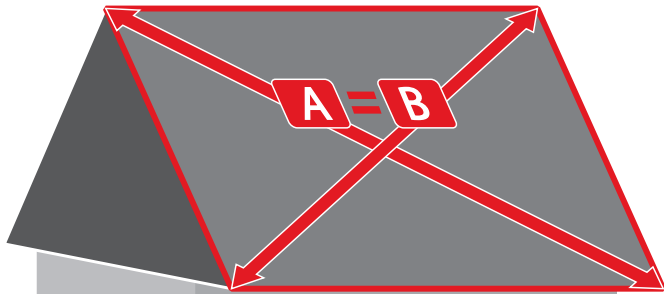

3

3a

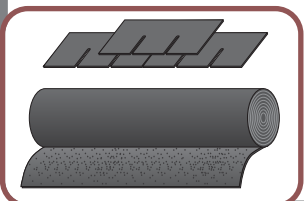
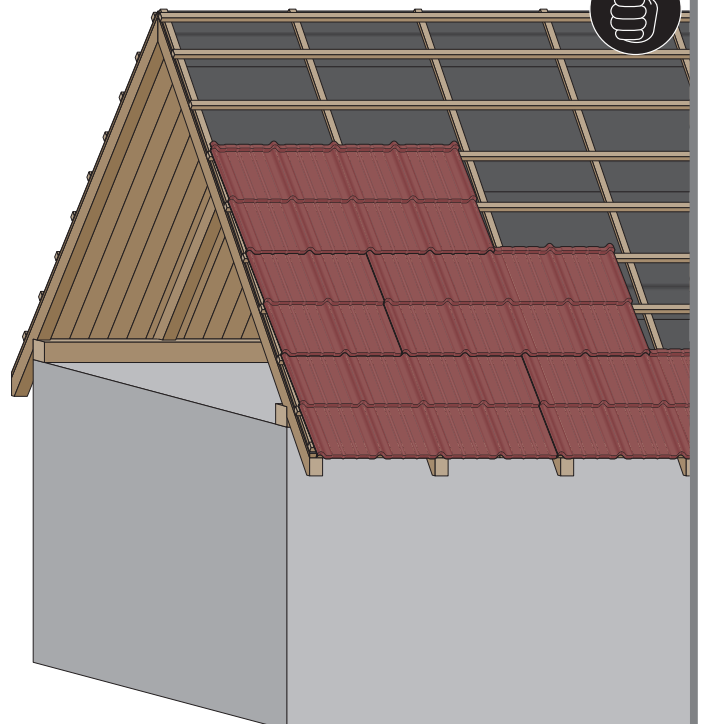
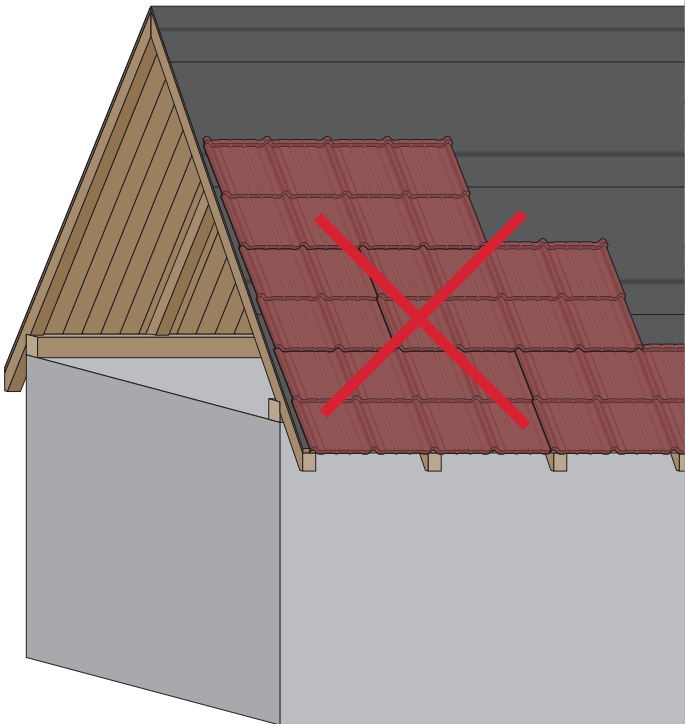
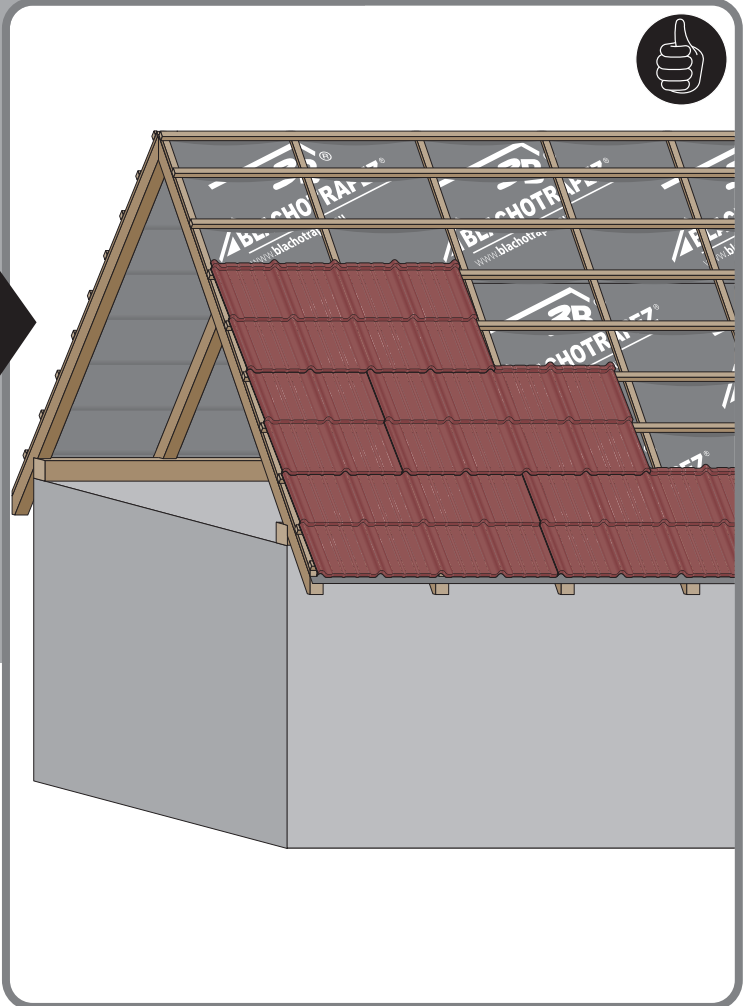
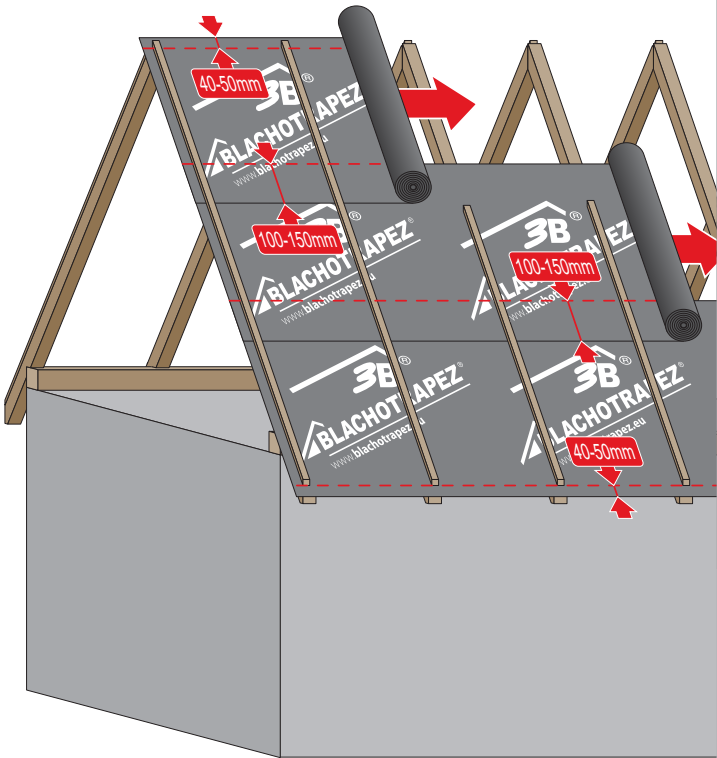

3b

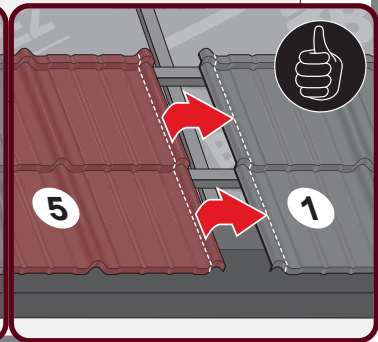
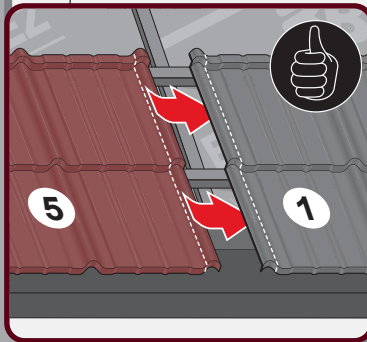
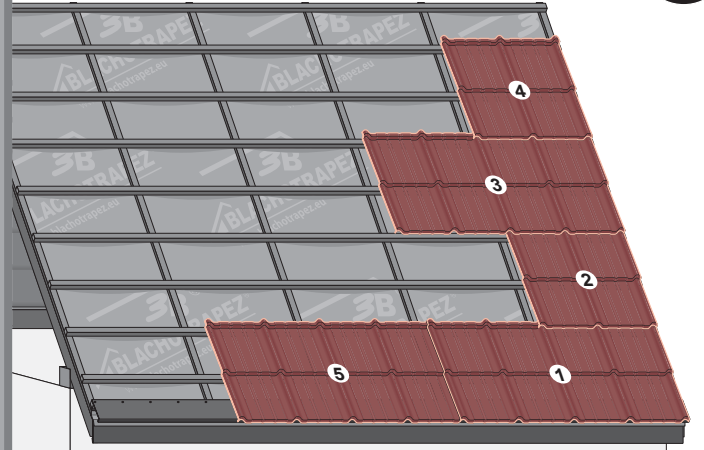
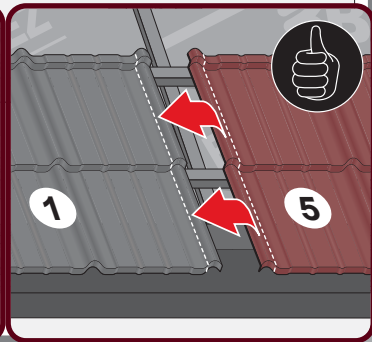
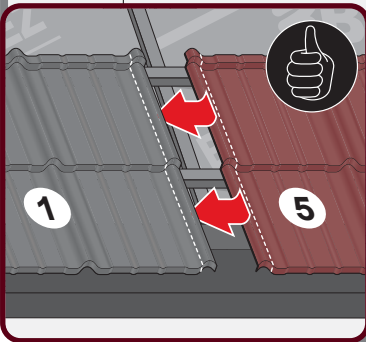
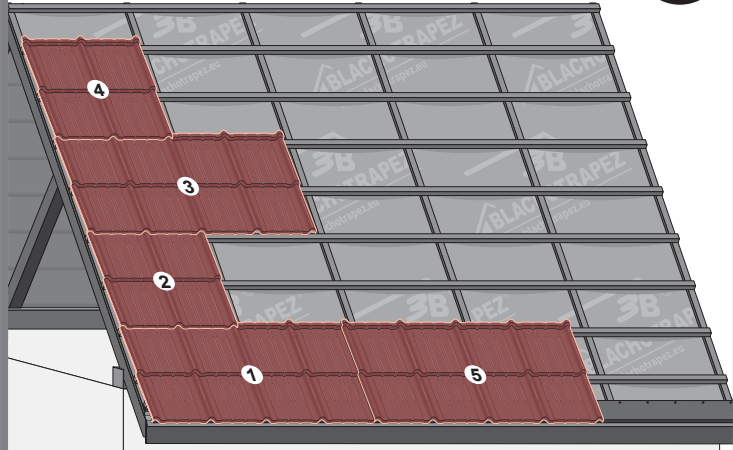
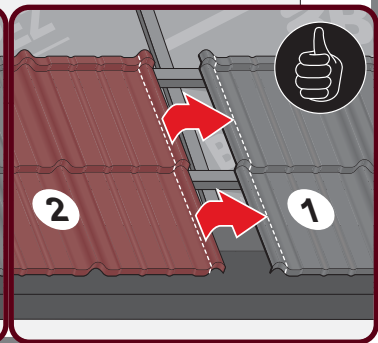
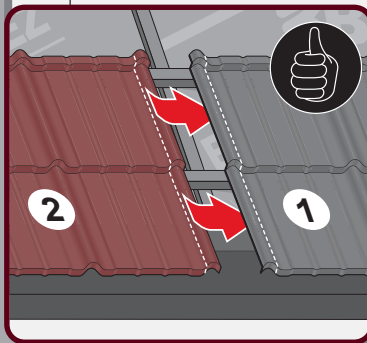
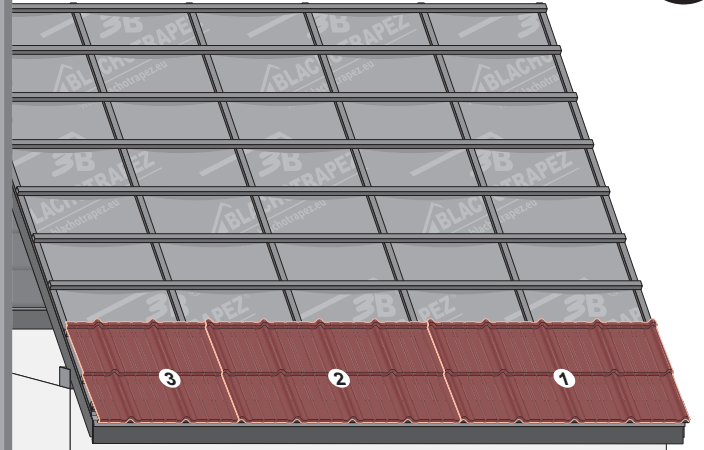
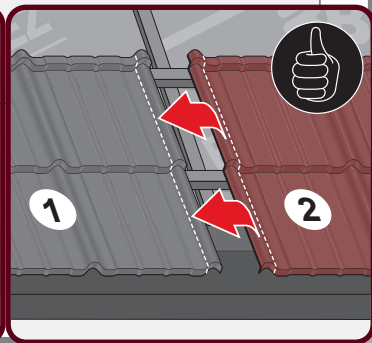
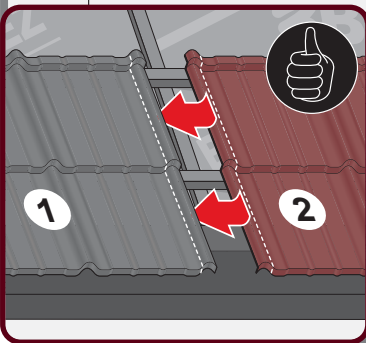
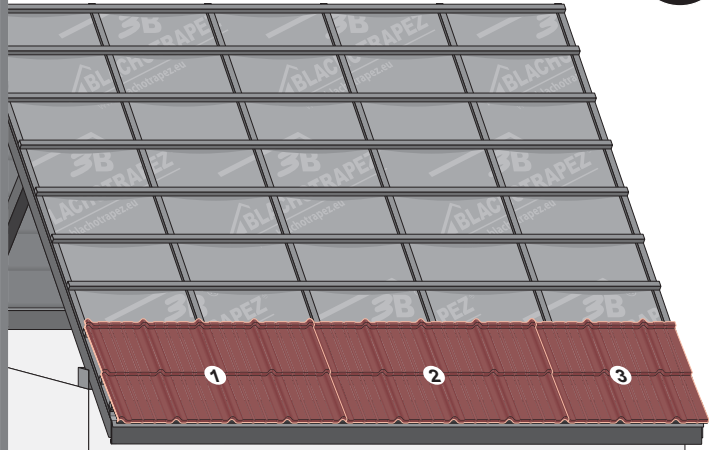

3c

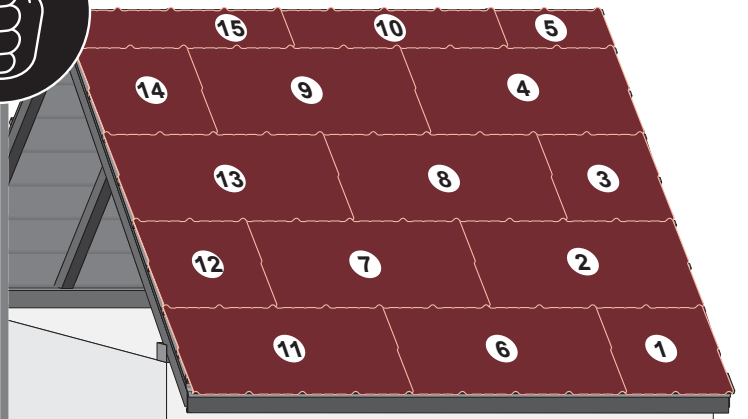

3d

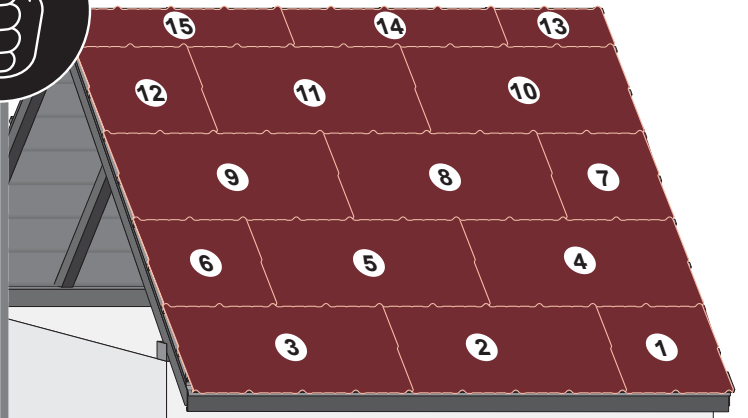

3e

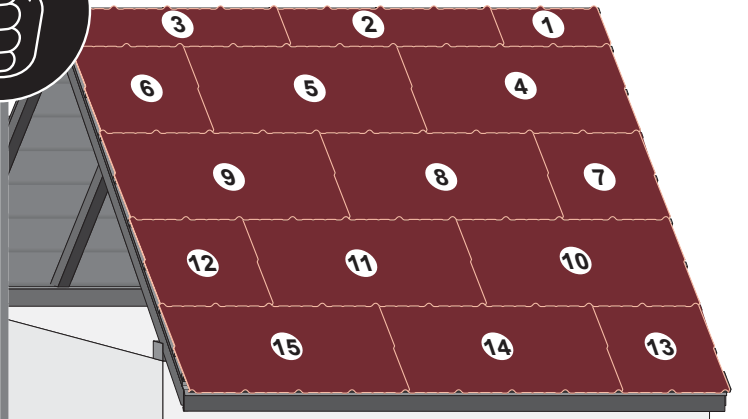

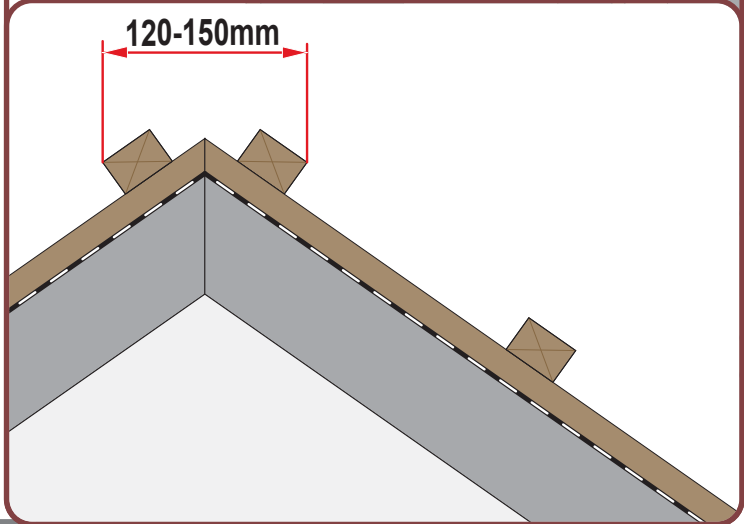
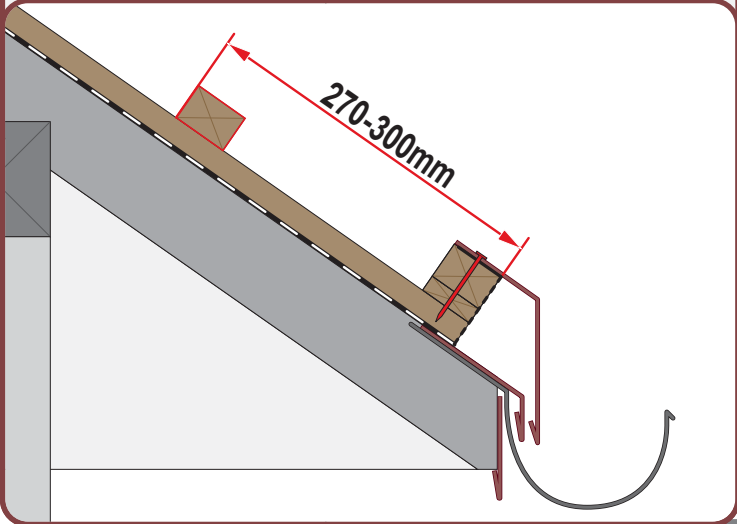
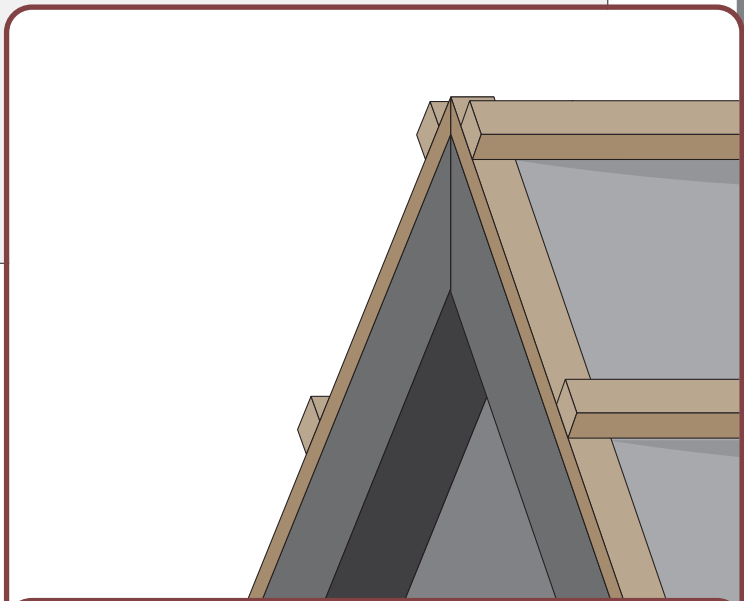
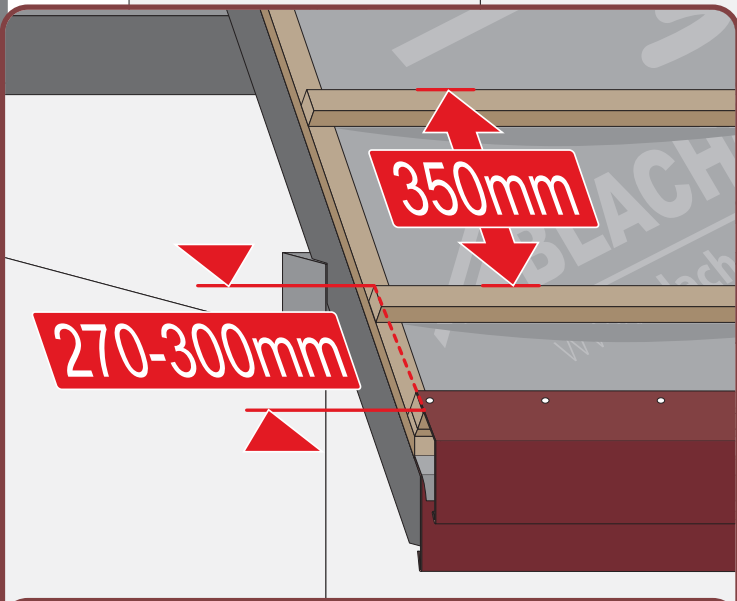
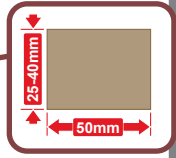
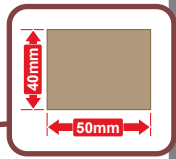
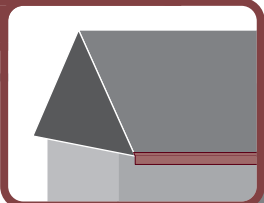
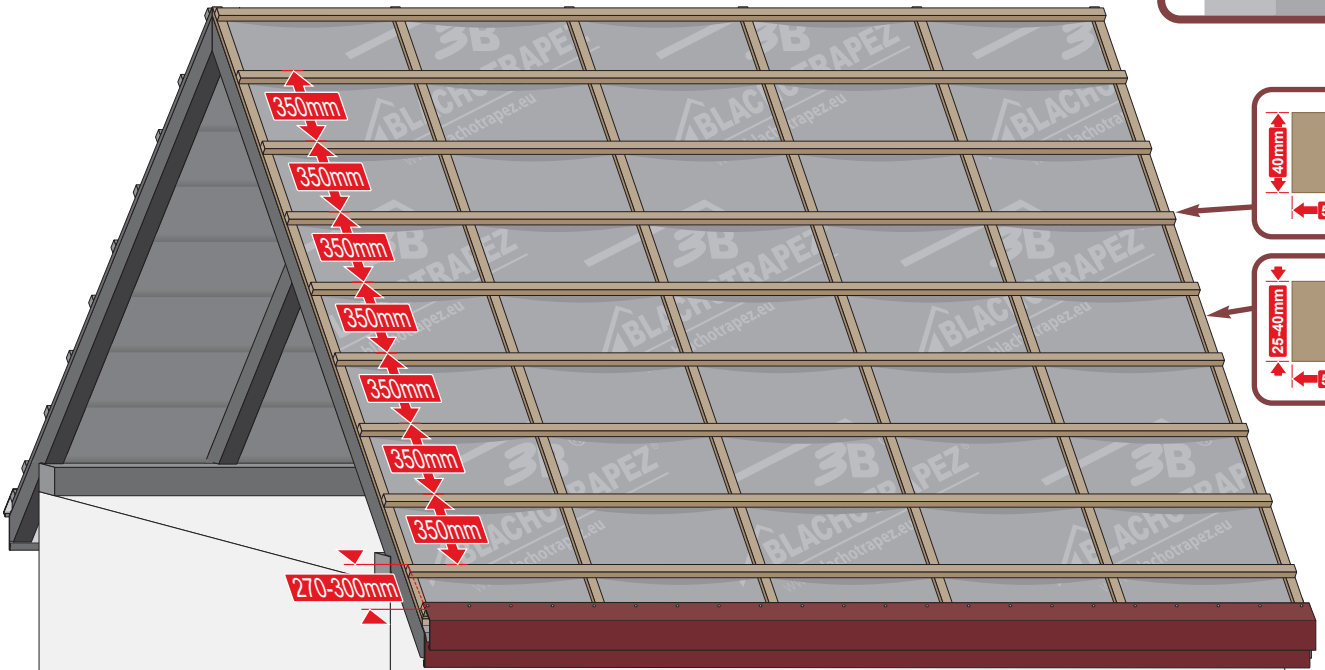

5a

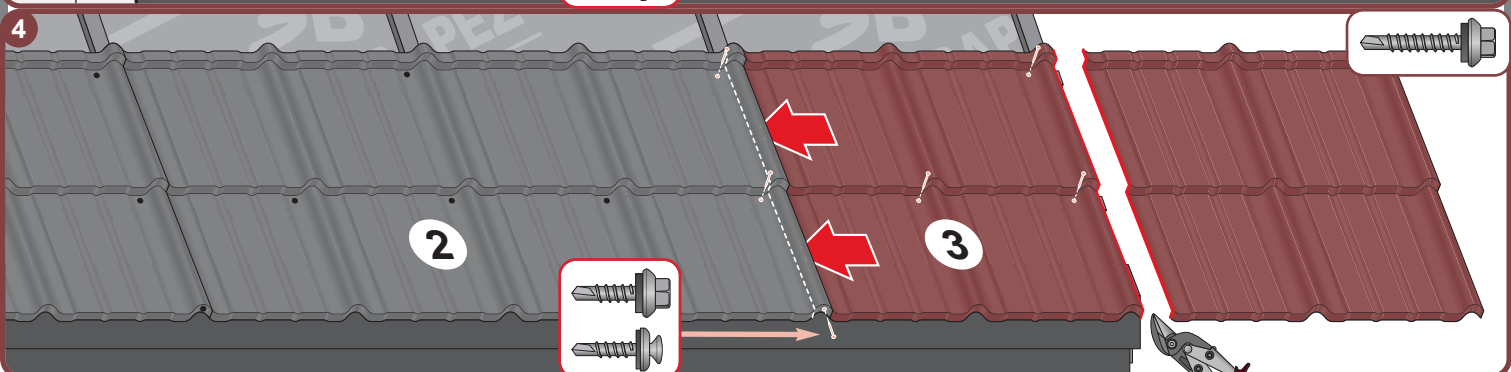
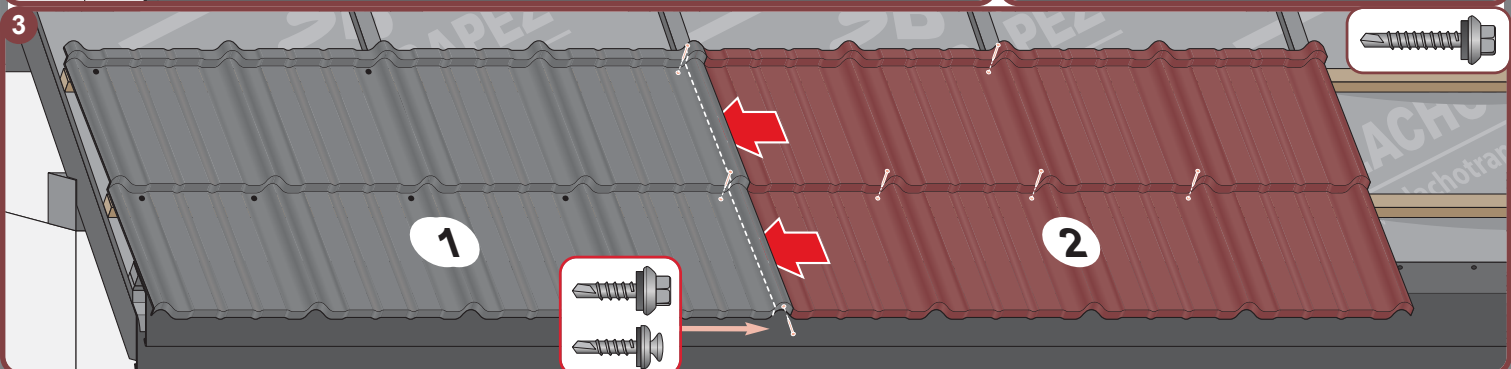
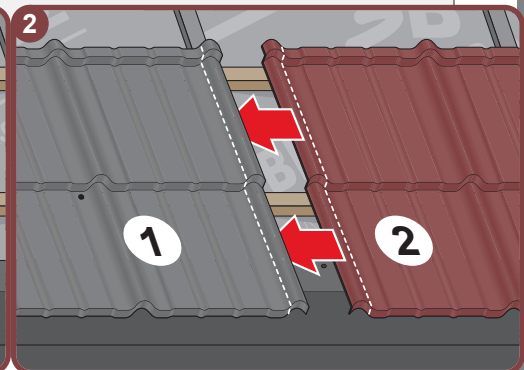
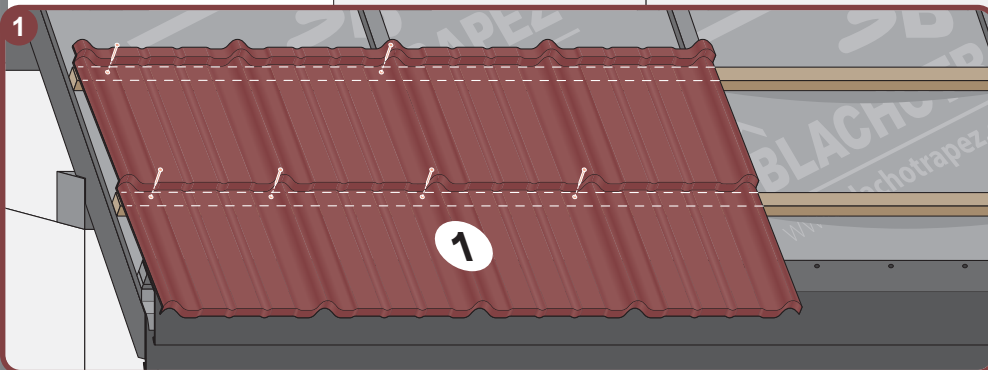
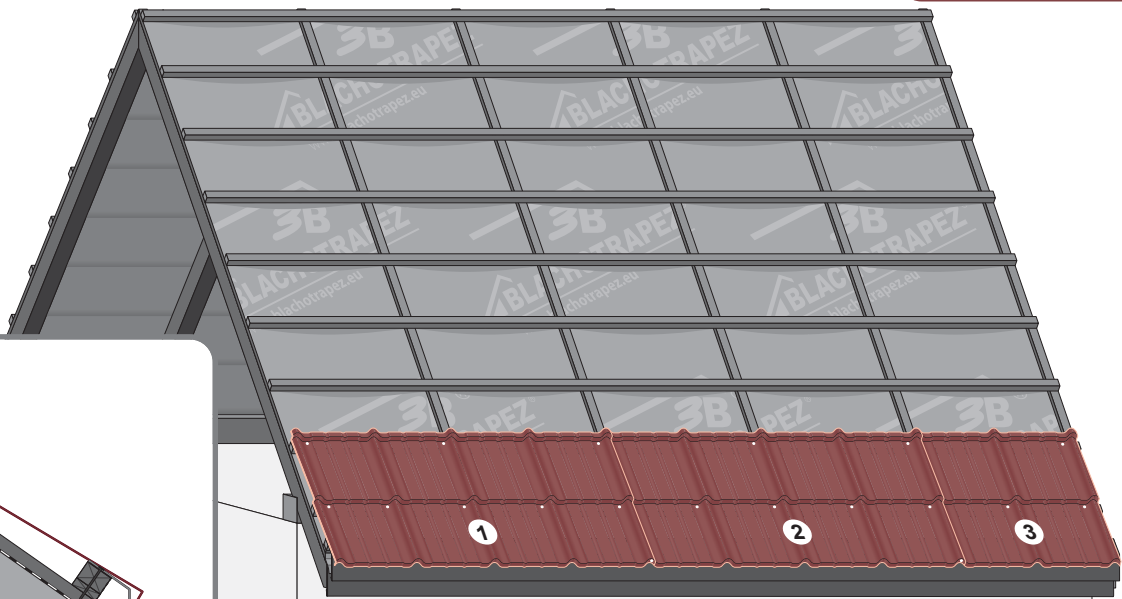
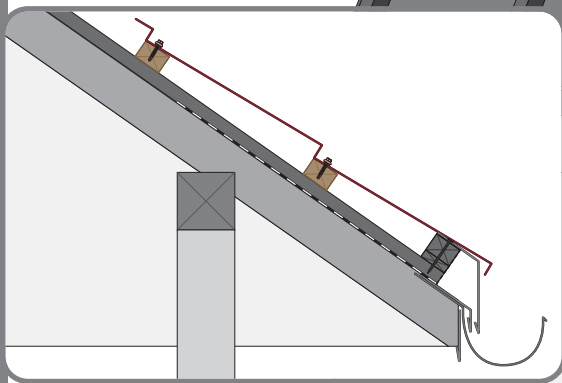
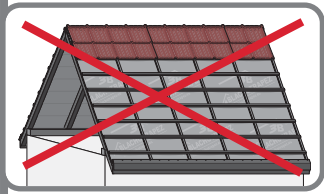
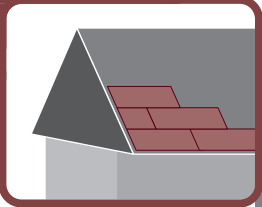

5b

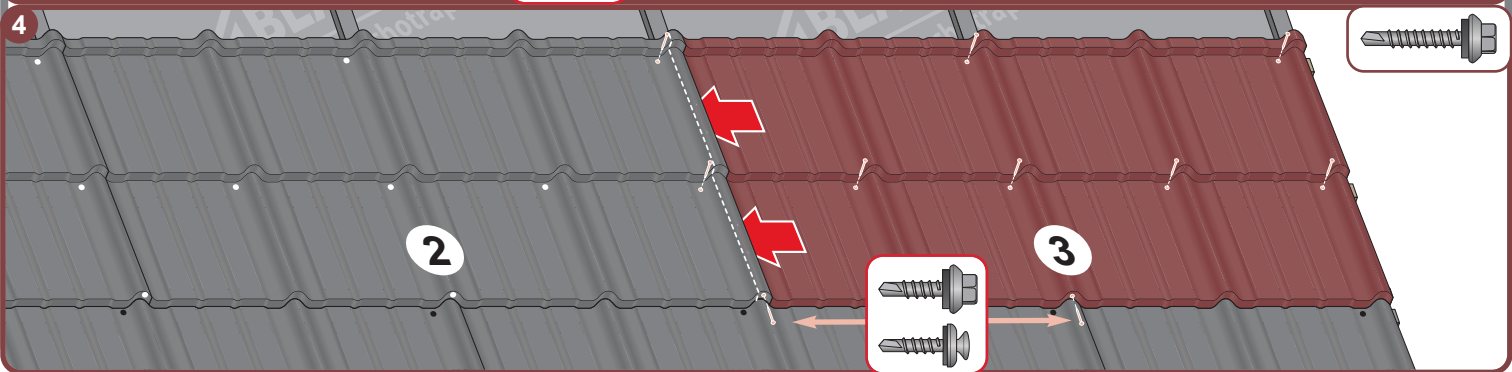
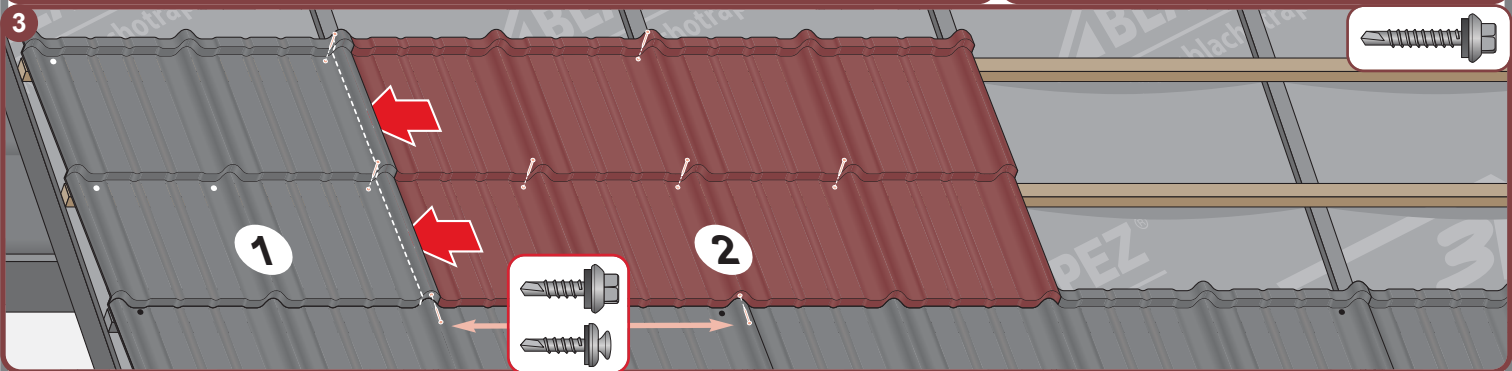
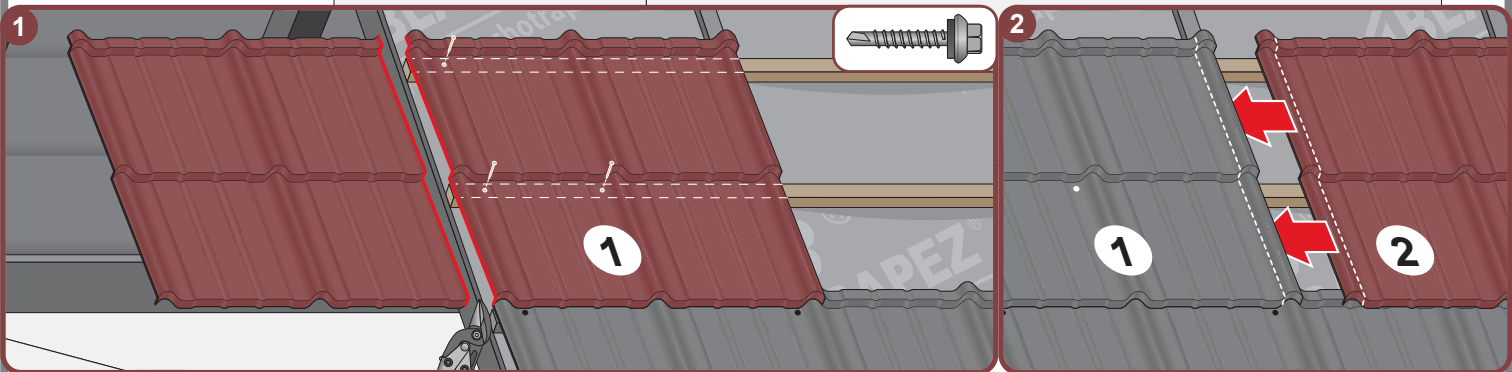
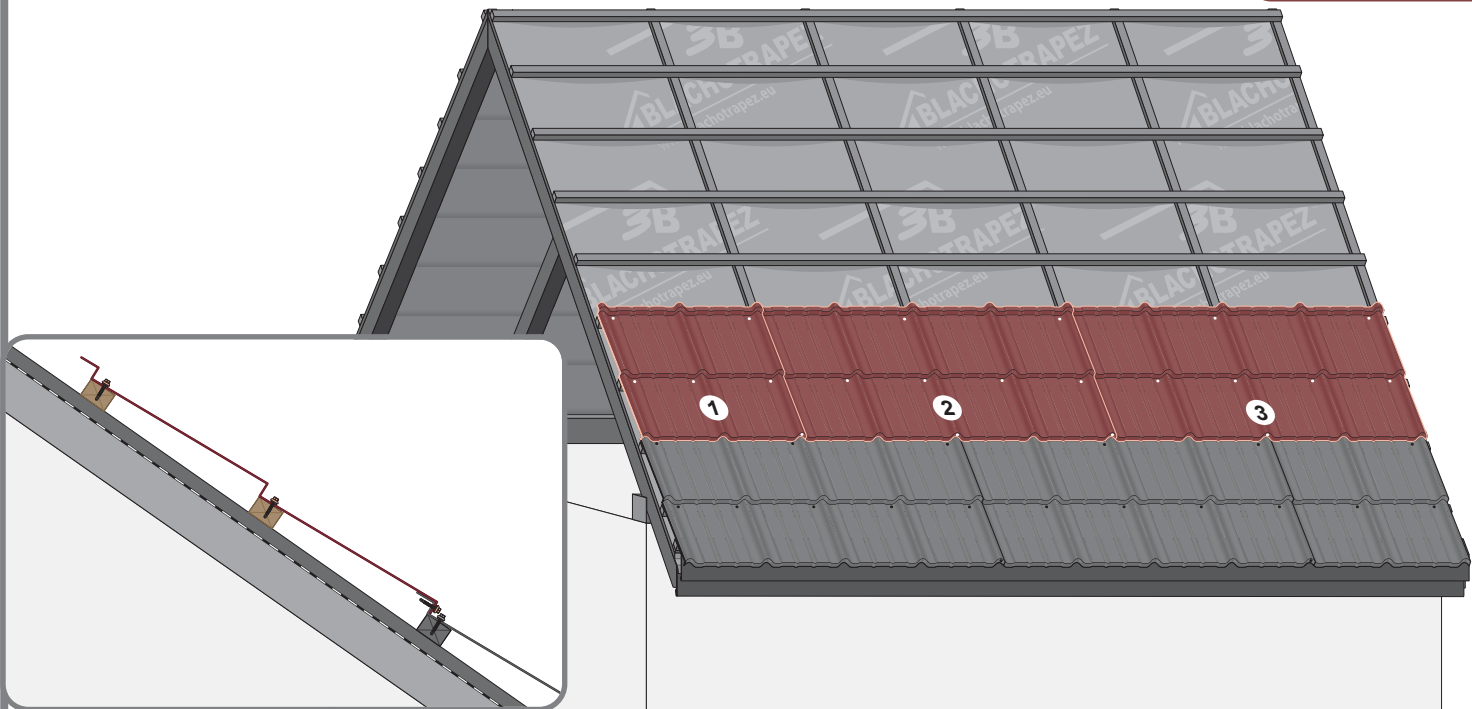
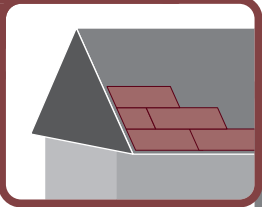

5c

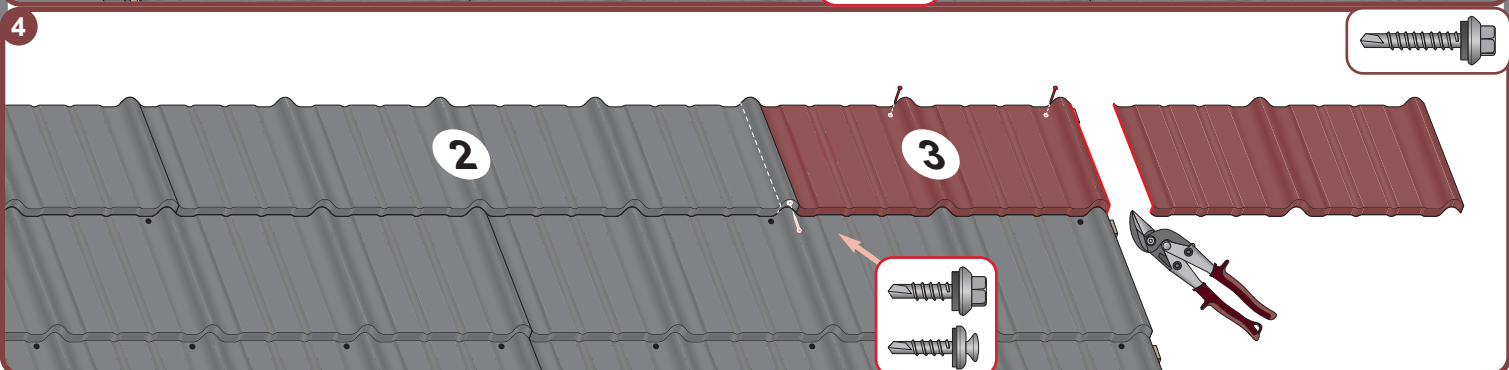
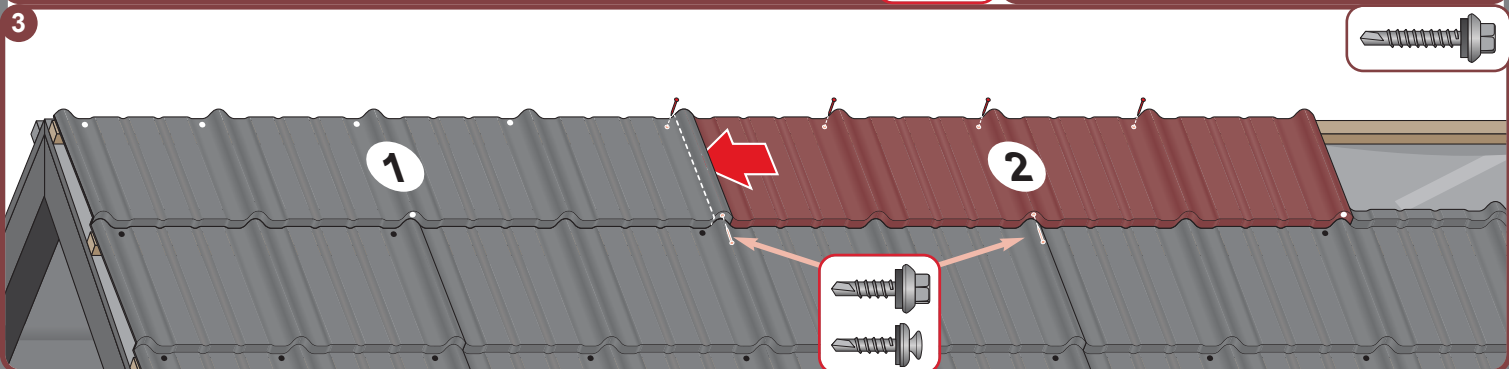
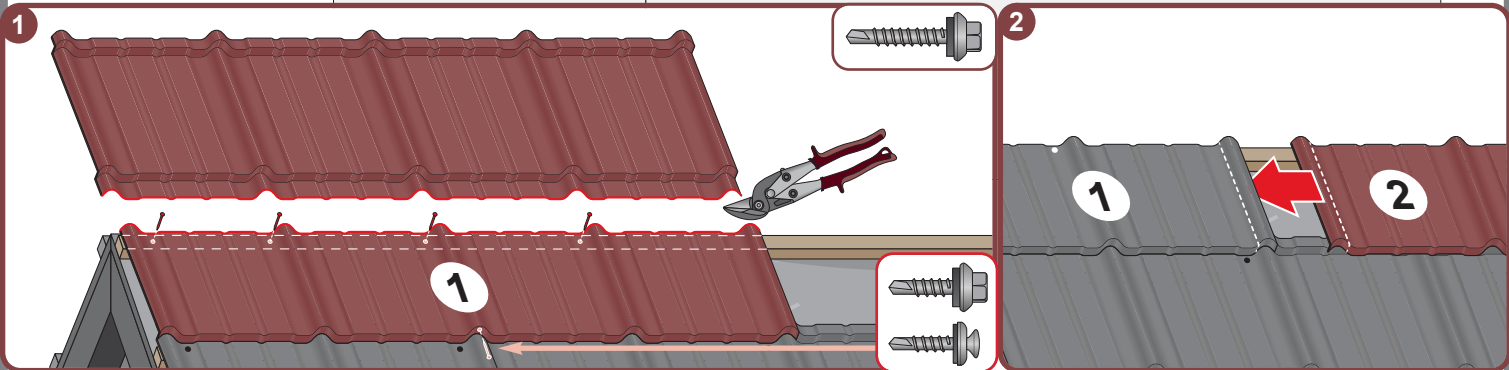
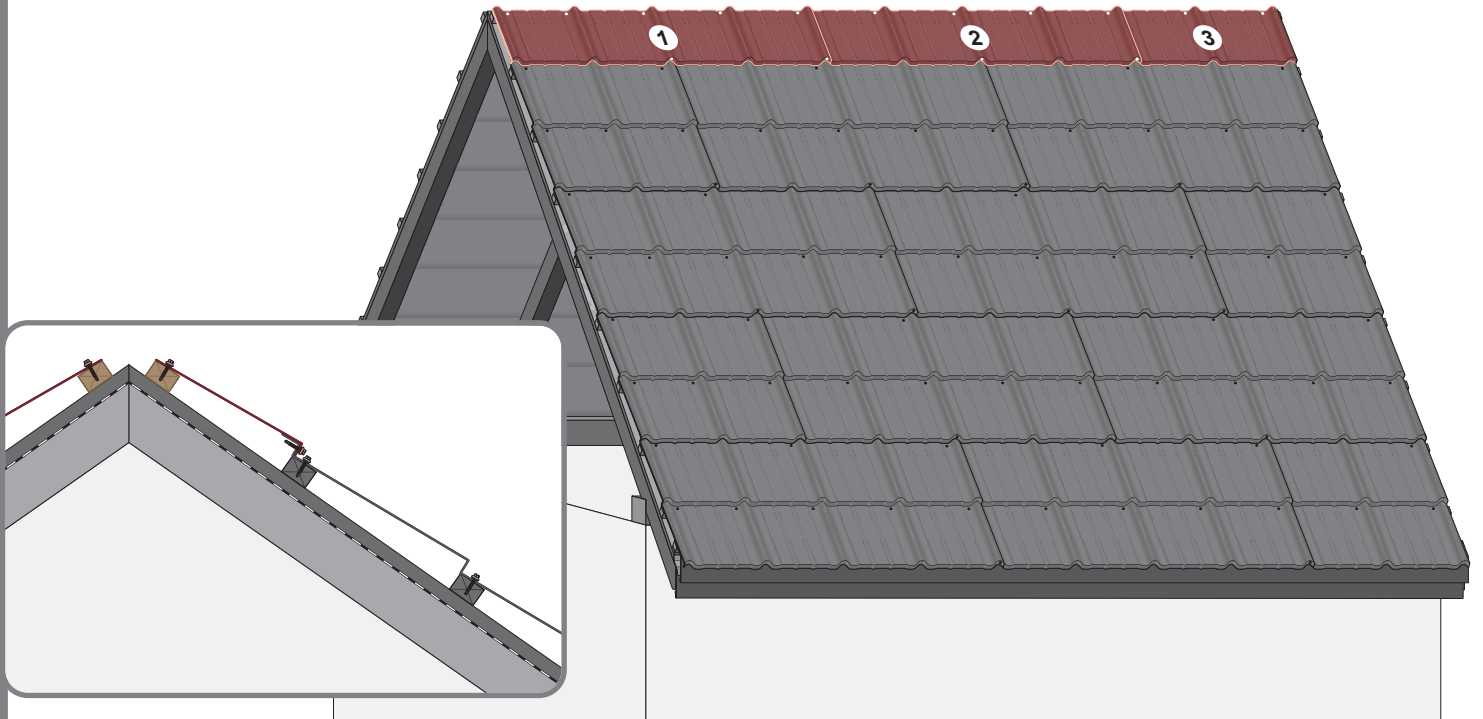
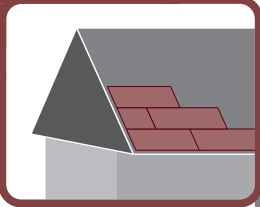

5d

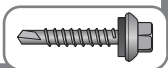
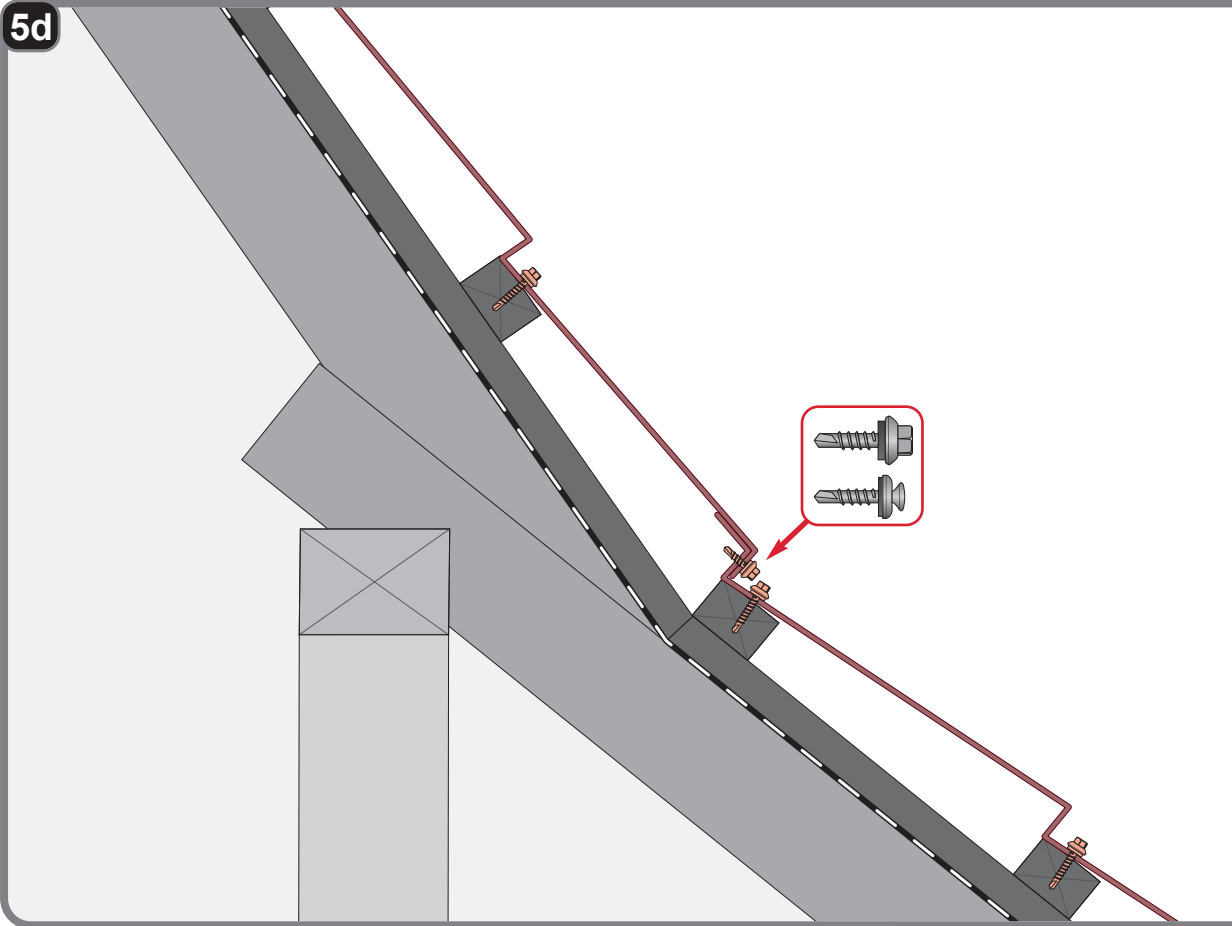
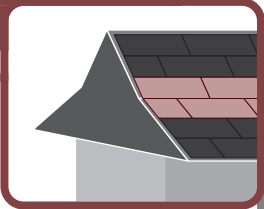

5e

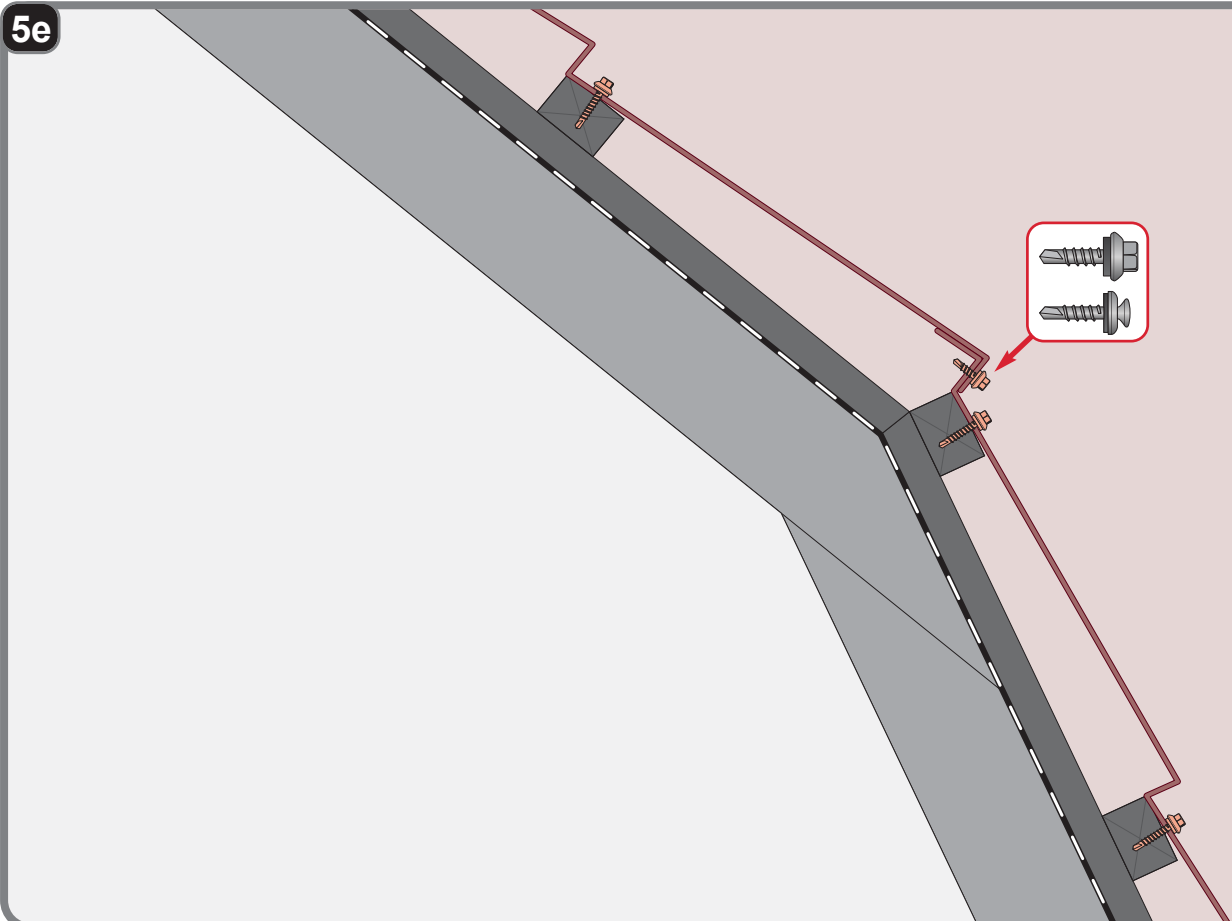
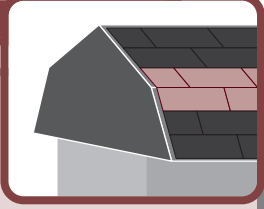

6a

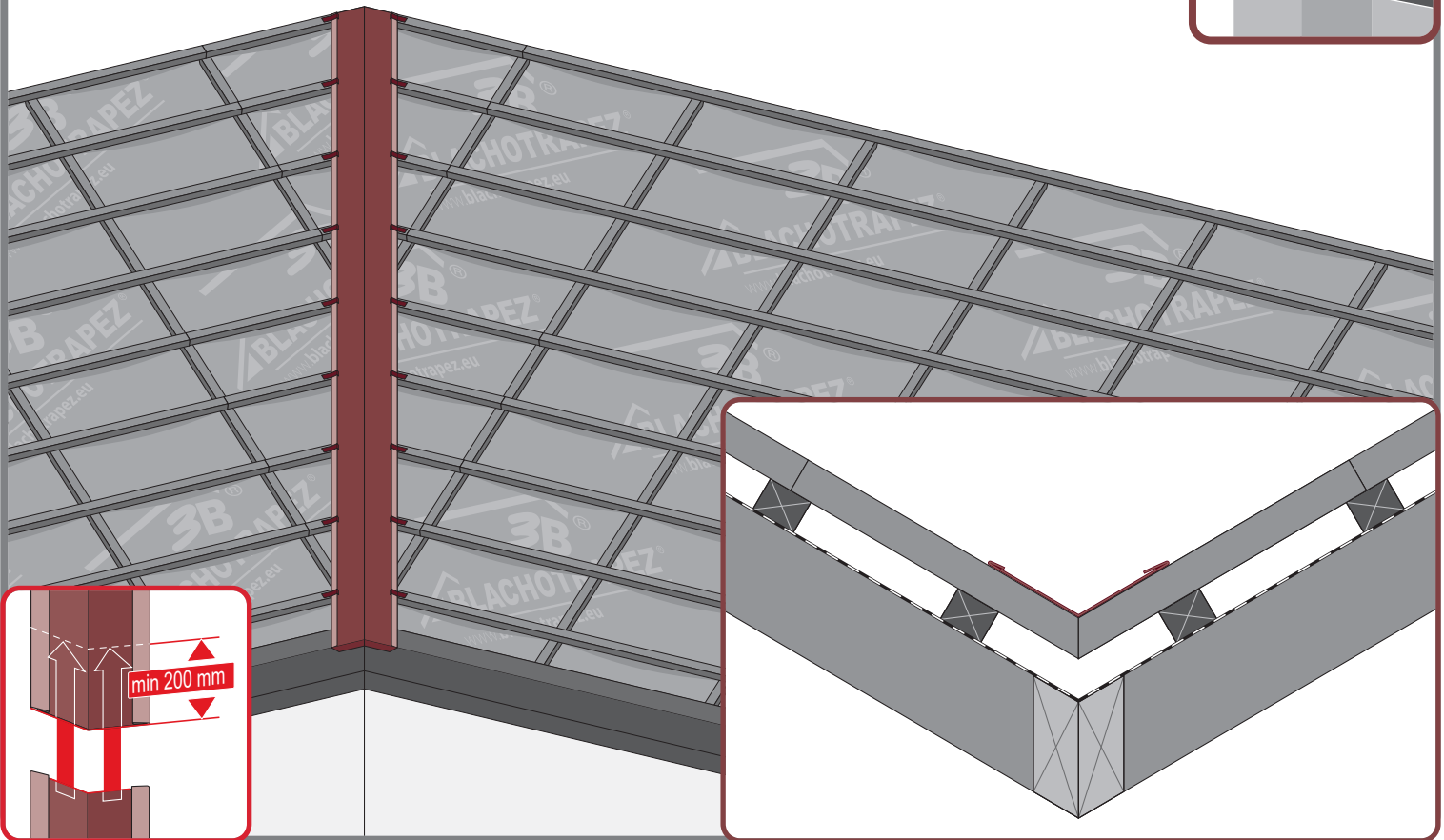

6b

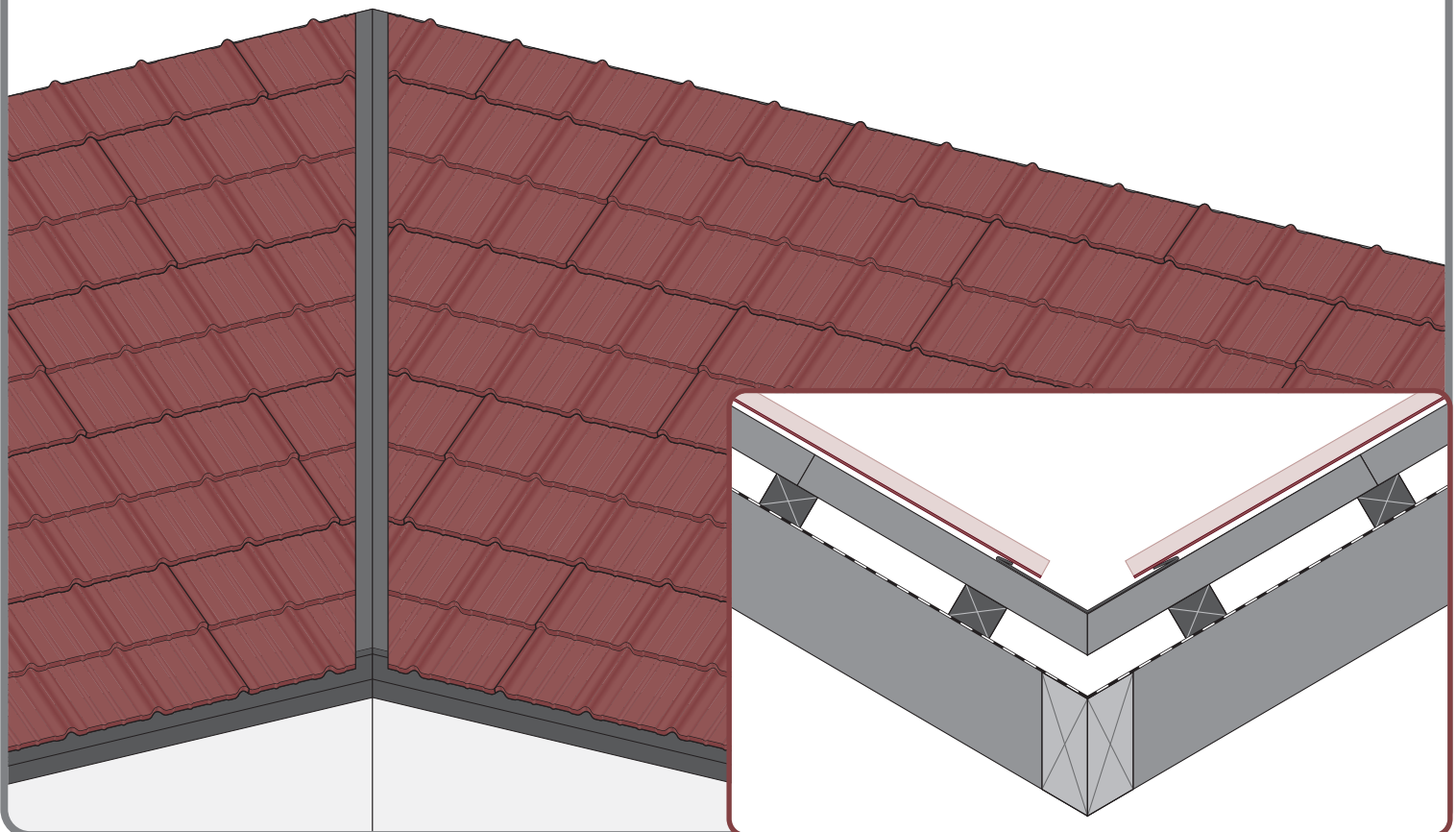

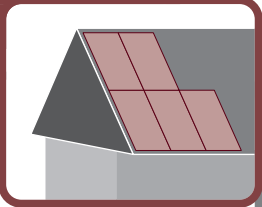

7a

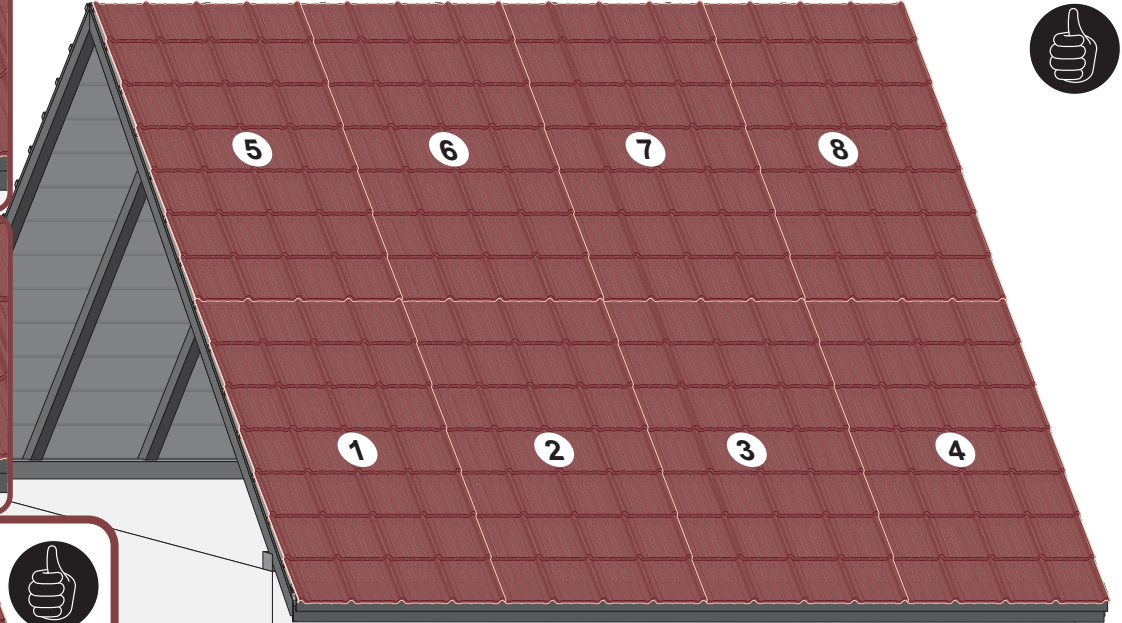
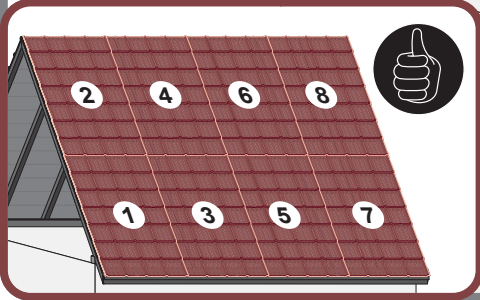
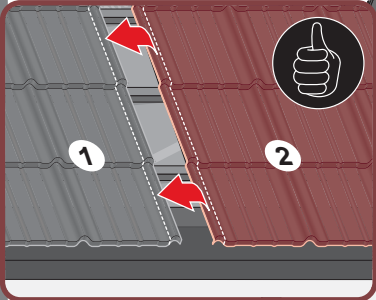
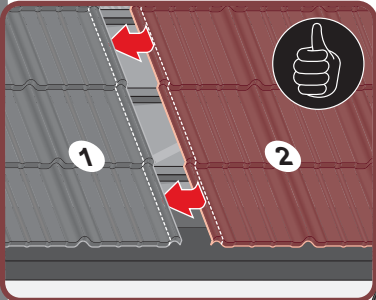

7b

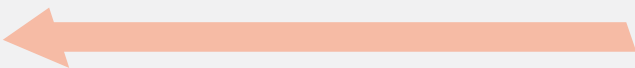
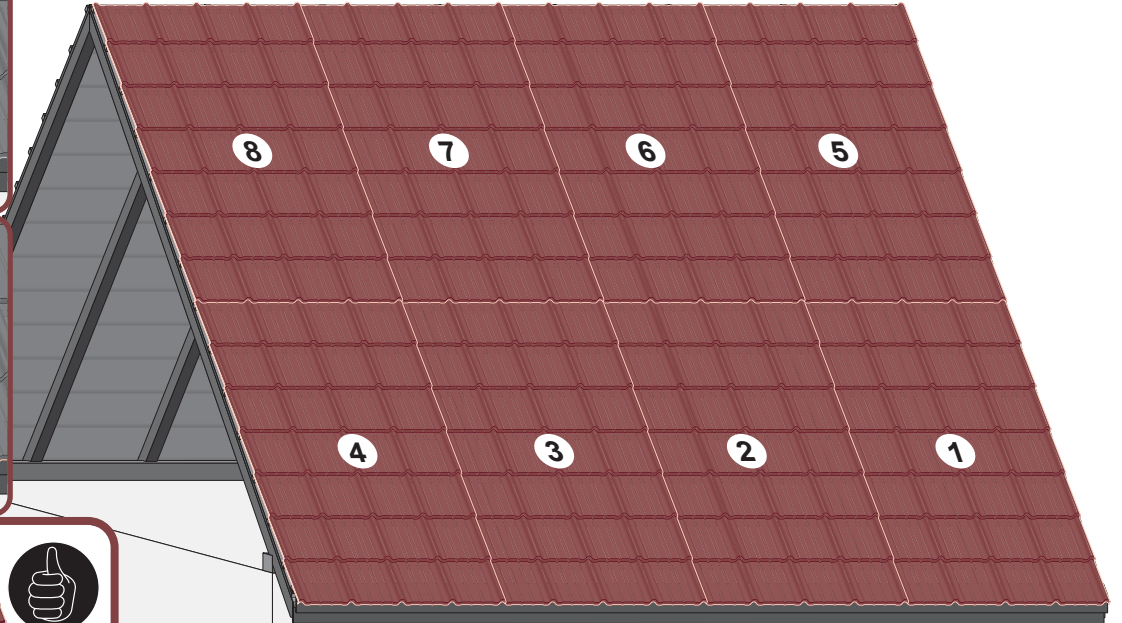
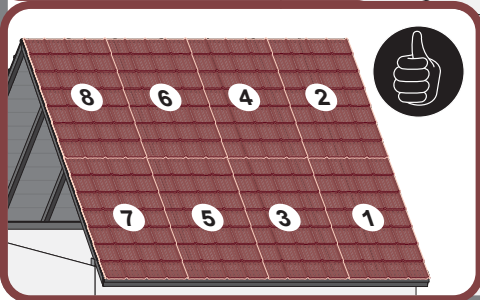
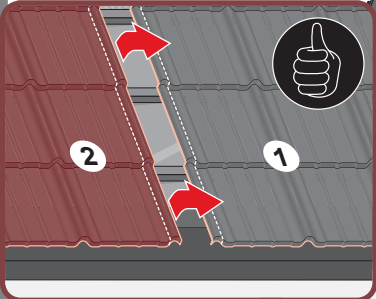
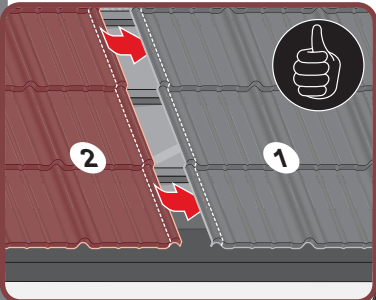

8a

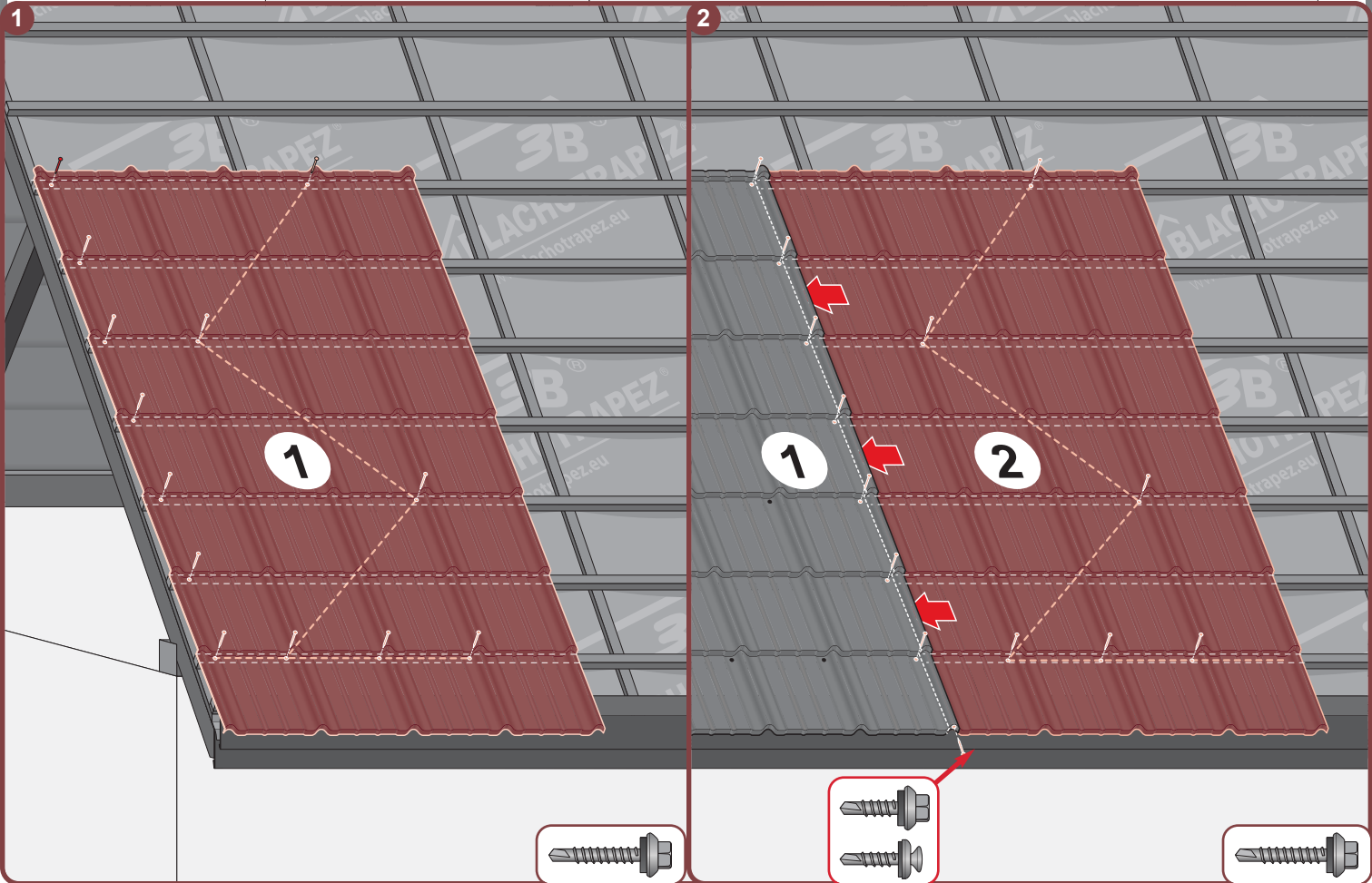
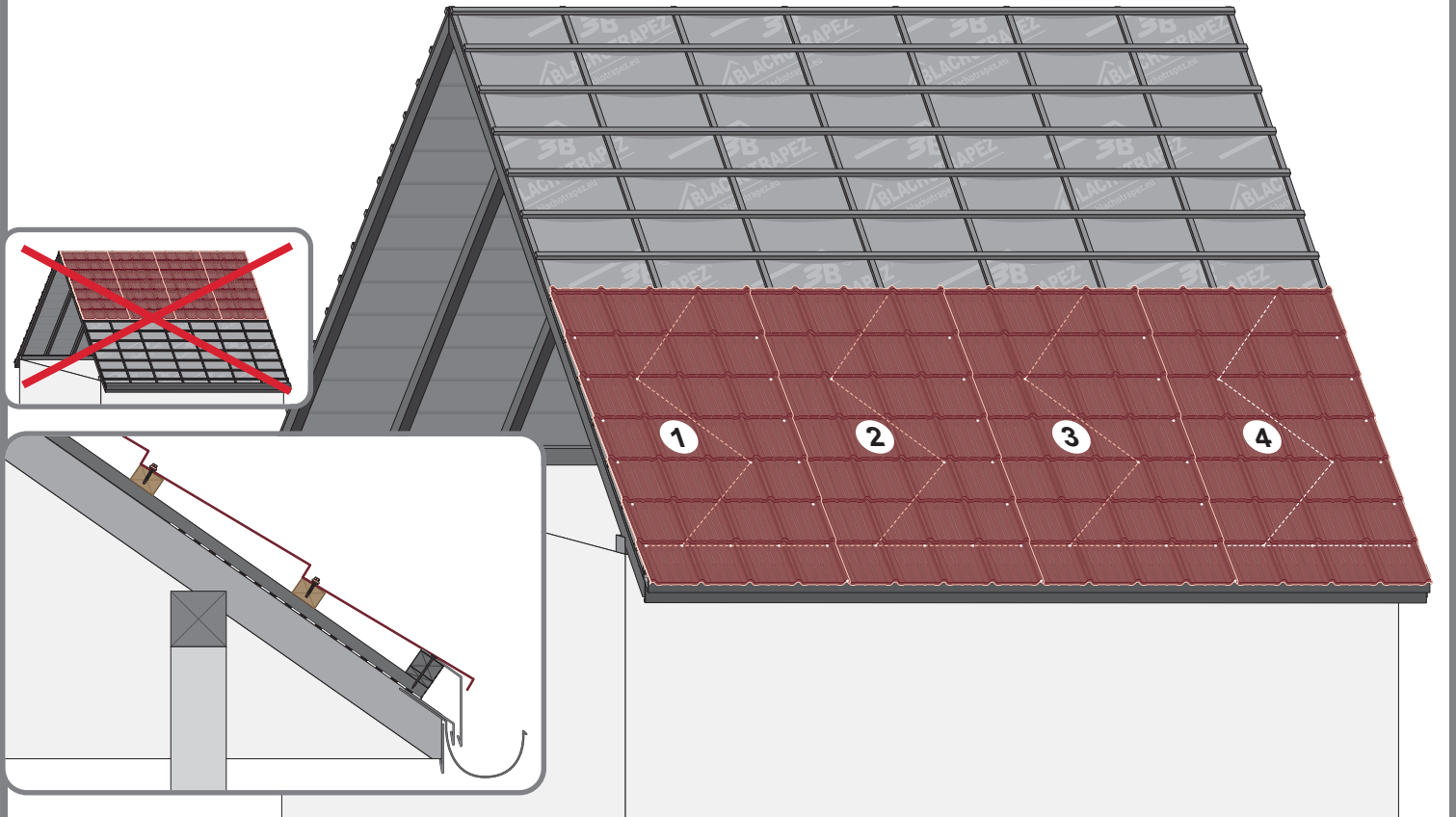
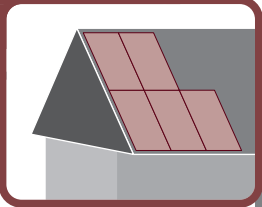

8b

